

TIMING TOOLS

ALFA ROMEO	122	MINI	167
AUDI	124	MITSUBISHI	168
BMW	134	NISSAN	170
CHRYSLER/DODGE	142	PEUGEOT	171
CITROEN	142	PORSCHE	174
FIAT	142	RANGE ROVER	174
FORD	143	RENAULT	174
HOLDEN	153	SAAB	176
HONDA	159	SKODA	176
HYUNDAI	159	SSANGYONG	177
JAGUAR	162	SUBARU	178
JEEP	161	TOYOTA	180
KIA	160	UNIVERSAL	184
LAND ROVER	161	VOLKSWAGEN	181
MAZDA	159, 163	VOLVO	183
MERCEDES	164		

TIMING TOOLS

INTRODUCTION

- The Toledo Timing Tool range consists of uniquely designed engine timing and locking tool kits required for the servicing and repairs of modern passenger vehicle engines for the Australian and New Zealand vehicle car parc.
- Each kit has been designed to provide maximum market coverage for petrol and/or diesel vehicle applications in the servicing of timing belts, timing chain, gears and other engine repairs. Kits are available in master, popular and universal applications.
- The range has been developed for use within original manufacturer's service specifications. As the timing tool kit must be compatible with the vehicle application, always refer to manufacturer's service notes or bulletins to ensure correct servicing instructions. Each kit features an OEM tool identification guide to enable correct tool selection.
- Each kit is individually supplied in custom moulded EVA foam and strong metal storage box

NOTE: Incorrect tool use during repairs can lead to serious engine damage. Toledo recommends that repairs be carried out by a trained professional.

ALFA ROMEO

TIMING TOOL KIT

- Suitable for popular 1.9L – 2.4L diesel engine applications
- For the locking and alignment of the camshafts, crankshaft and injection pump during the removal and installation of the engine timing belt and other engine servicing and repairs

APPLICATION LIST*

Part No.	Make & Model	Engine	Year
304720	Alfa Romeo		
	147	1.9L	2006 - 2009
	159	1.9L, 2.4L	2006 - 2012
	Giulietta (2.0 JTD-M)	2.0L	2012 - 2015
	Fiat		
	Bravo	1.9L	2007 - 2008
	Doblo (Maxi)	2.0L	2014 - 2018
	Freemont (Urban)	2.0L	2013 - 2017
	Multipla	1.9L	2000 - 2010
	Punto	1.9L	2006 - 2009
	Ritmo	1.9L	2008 - 2010
	SAAB		
	9-3 (1.9 TiD)	1.9L	2007 - 2012
	9-5 (2.0 TiD)	2.0L	2011 - 2012



CONTENTS

Tool Ref.	Toledo Tool No.	OEM Tool No.	Description
A	A0067		Bolt
B	A0109	1 860 965 000	Injection Pump Timing Pin
C	A0181	1 860 846 001	Flywheel Locking Tool
D	A0184	1 870 896 900	Camshaft Locking Tools
E	A0333	1 860 905 000, 1 860 905 010, 2 000 003 000	Crankshaft Alignment Tool
F	A0422	1 860 898 000	Flywheel Locking Tool

TOOL REFERENCE

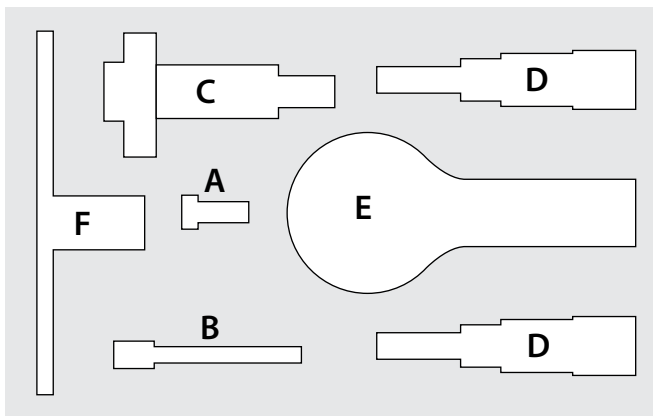

Also suitable: Part No. 304712 TIMING TOOL MASTER KIT

- Suitable for popular Alfa 147, 159 & Giulietta, 1.9L - 2.4L (DOHC) diesel engine applications
- For full kit contents refer to page 154



Scan here for link to part finder

TIMING & ALIGNMENT TOOL MASTER KIT



- Suitable for popular 1.2L – 2.0L DOHC 16V petrol and 1.6L - 1.9L diesel engine applications
- For the locking and alignment of the camshaft and crankshaft during the removal and installation of the engine timing belt and other engine servicing and repairs



APPLICATION LIST*

Part No.	Make & Model	Engine	Year
304705	Abarth		
	500	1.4L (312A)	2011 - 2014
	595	1.4L (312A)	2014 - 2018
	695	1.4L (312A)	2011 - 2016
	Alfa Romeo		
	147, 156	2.0L (AR32310)	1999 - 2009
	Giulietta (1.4)	1.4L (198A4)	2013 - 2015
	GTV (2.0)	2.0L (AR32301)	1998 - 2003
	Mito	1.4L (198A4 / 8)	2009 - 2011
	Spider	2.0L (AR32301)	1998 - 2002
	Spider (Velcoe)	2.0L (AR32310)	2002 - 2003
	Fiat		
	500	1.4L (169A3)	2008 - 2012
	Punto	1.4L (198A4)	2008 - 2010
	Punto	1.9L	2006 - 2009
	Ritmo	1.4L	2008 - 2010
	Ritmo	1.9L	2008 - 2010

CONTENTS

Tool Ref.	Toledo Tool No.	OEM Tool No.	Description
A	A0014	1 860 987 000	Tensioner Tool
B	A0031	1 867 030 000	Flywheel Locking Tool
C	A0033	1 860 680 000, 1 860 771 000	Flywheel Locking Tool
D	A0040	1 860 992 000	Piston Position Tools
E	A0041	1 860 895 000	Adaptor-Tdc Indicator
F	A0056		Bolt
G	A0061		Bolt
H	A0067		Bolt
I	A0081	1 860 965 000	Injection Pump Timing Pin
J	A0175	6MM	Crankshaft Locking Tool and Bolt
K	A0183	1 860 876 000	Tensioning Tool
L	A0230	7004-TG	Camshaft Timing Pin
M	A0235	1.822.154.000	Balance Shaft Tension Tool
N	A0236	1.822.149.000	Tensioning Tool
O	A0251	1 860 874 000	Camshaft Locking Tools
P	A0287	1 860 985 000	Camshaft Locking Tools
Q	A0295	1.825.041.000	Camshaft Locking Caps
R	A0313	1 860 831 000	Camshaft Adjusting Wrench
S	A0333	1 860 905 000, 1 860 905 010, 2 000 003 000, 2 000 003 000	Crankshaft Alignment Tool
T	A0336	2 000 004 500	Crankshaft Locking Tool
U	A0347	1 860 876 000	Tensioning Tool
V	A0422	1 860 898 000	Flywheel Locking Tool
W	A0609	2 000 015 800	Camshaft Sprocket Locking Tool
X	A0614	1.822.146.000, 1.822.156.000, 1 860 831 000, 1 860 831 001	Camshaft Holding Tool

TOOL REFERENCE

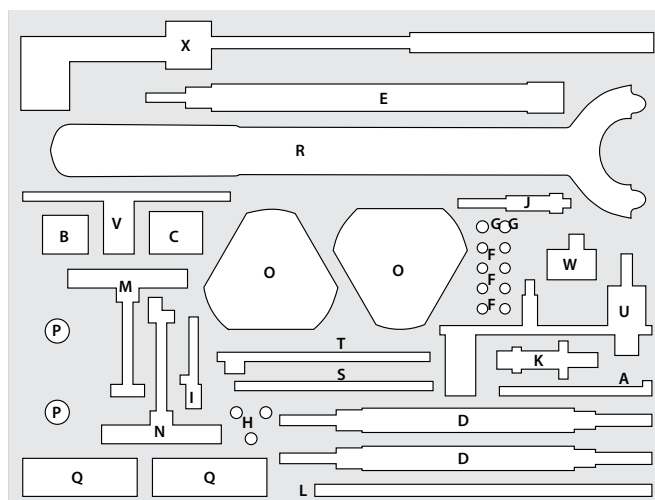

TIMING TOOL KIT

- Suitable for popular 1.6L – 2.0L petrol engine applications
- For the locking and alignment of the camshafts, crankshaft and tensioner during the removal and installation of the engine timing belt, chain and other engine servicing and repairs



APPLICATION LIST*

Part No.	Make & Model	Engine	Year
304714	Audi		
	A3 (8L, 8P)	1.6L - 2.0L	1997 - 2011
	A4 (B5, B6, B7)	1.8L, 2.0L	1995 - 2009
	A6 (C6)	2.0L (BPJ)	2006 - 2008
	TT	1.8L, 2.0L	1999 - 2015
	Skoda		
	Octavia (1Z)	2.0L	2005 - 2009
	Volkswagen		
	Beetle	1.6L - 2.0L	2000 - 2011
	Bora (1J)	2.0L	1999 - 2005
	Caddy (2K)	1.6L	2004 - 2010
	EOS (1F)	2.0L (BWA)	2007 - 2008
	Golf	1.6L - 2.0L	1995 - 2013
	Jetta (1K)	2.0L	2005 - 2009
	Passat (3B, 3C)	1.8L, 2.0L	1997 - 2008
	Polo (9N)	1.8L (BJX)	2005 - 2010
	Scirocco (1S)	2.0L (CDLC)	2010 - 2017

CONTENTS

Tool Ref.	Toledo Tool No.	OEM Tool No.	Description
A	A0002	T40011	Tensioner Bolt / Locking Pin
B	A0011	T10115	Chain Tensioner Locking Pin
C	A0013	T10008	Tensioner Locking Tool
D	A0043	M5 X 55mm	Stud & Nut
E	A0058	3369	Support Guides
F	A0083		Auxiliary Drive Belt Tensioner Locking Tool
G	A0163	T10092	Bolt & Nut (M5)
H	A0176	3366	Camshaft Sprocket Holding Tool
I	A0198	T40098	Auxiliary Drive Belt Tensioner Locking Pin
J	A0210	3204, T10060, T10060A	Auxiliary Drive Belt Tensioner Locking Pin
K	A0255	40080, T20079, T40080	Camshaft Adjuster Socket
L	A0313	3036	Camshaft Adjusting Wrench
M	A0317	T10020, U-30009, V159	Tensioner Pulley Adjusting Tool
N	A0318	3387, T10020, V159	Tensioner Pulley Adjusting Tool
O	A0350	T10252	Camshaft Alignment Tool

TOOL REFERENCE

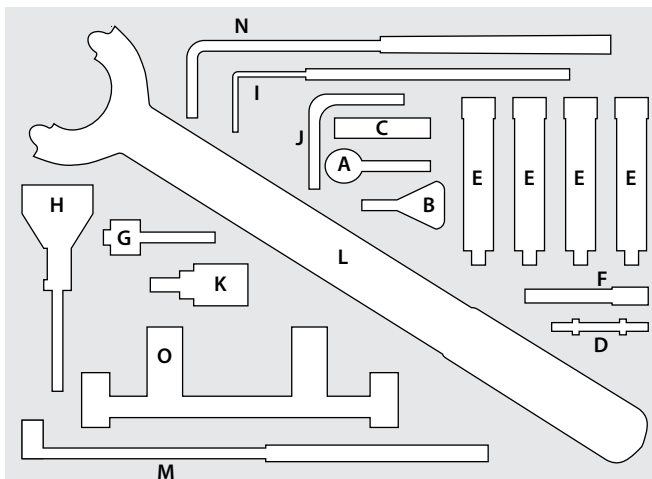

TIMING TOOL MASTER KIT  

- Suitable for various 1.4L – 2.0L petrol and diesel engine applications
- For the locking and alignment of the camshafts, crankshaft and tensioner during the removal and installation of the engine timing belt, chain and other engine servicing and repairs



APPLICATION LIST*

Part No.	Make & Model	Engine	Year
304715	Audi		
	A1, A3, A4, A6	1.6L - 2.0L	1995 - 2015
	A3, A4, A5, A6 (Diesel)	1.6L - 2.0L	2004 - 2015
	Q3	2.0L (CULB)	2015 - 2018
	Q3 (Diesel)	2.0L	2012 - 2018
	TT	1.8L, 2.0L	1999 - 2015
	Skoda		
	Fabia	1.4L (CGGB)	2013 - 2014
	Octavia, Roomster, Superb, Yeti (Diesel)	1.6L - 2.0L	2006 - 2018
	Volkswagen		
	Amarok (Diesel)	2.0L	2011 - 2018
	Beetle, Caddy, EOS, Golf, Jetta, Passat, Polo, Scirocco	1.4L - 2.0L	1995 - 2017
	Beetle, Caddy, EOS, Golf, Jetta, Passat, Polo, Tiguan (Diesel)	1.6L - 2.0L	1995 - 2016
	Multivan, Transporter (Diesel)	1.9L, 2.0L	2004 - 2018
	Transporter	2.0L (AXA)	2004 - 2010

CONTENTS

Tool Ref.	Toledo Tool No.	OEM Tool No.	Description
A	A0002	T40011	Tensioner Bolt/Locking Pin
B	A0010		Locking Pin
C	A0011	T10115	Chain Tensioner Locking Pin
D	A0013	T10008	Tensioner Locking Tool
E	A0022	3359, MP1-301	Camshaft Locking Tool
F	A0023	3411	Support Guides
G	A0025	T10016, T10074	Camshaft Locking Tool
H	A0043	M5 X 55MM	Stud & Nut
I	A0044		Set Screw (M5 X 60mm)
J	A0059	3369	Support Guides
K	A0083		Auxiliary Drive Belt Tensioner Locking Tool
L	A0111		Timing Pin
M	A0116	3418, T10098	Camshaft Setting Bar
N	A0143	T10172-4	Camshaft Sprocket Holding Tool Pins
O	A0163	T10092	Bolt & Nut (M5)
P	A0176	3366	Camshaft Sprocket Holding Tool
Q	A0189	T40001	Camshaft Sprocket Puller
R	A0197	T10264	Tensioner Pulley Adjusting Tool
S	A0198	T10265	Auxiliary Drive Belt Tensioner Locking Pin
T	A0209	3204, T10060, T10060A	Auxiliary Drive Belt Tensioner Locking Pin
U	A0210	3204, T10060, T10060A	Auxiliary Drive Belt Tensioner Locking Pin
V	A0272	3418, T10098	Camshaft Setting Bar
W	A0313	3036	Camshaft Adjusting Wrench
X	A0314	T10172	Universal Flange Holding Wrench
Y	A0317	3387, 10020, T10004, T10020, U-30009, V159	Tensioner Pulley Adjusting Tool
Z	A0318	3387, 10020, T10004, T10020, U-30009, V159	Tensioner Pulley Adjusting Tool
AA	A0322	T10028	Crankshaft Pulley Holding Tool
AB	A0323	3415, T30004	Crankshaft Pulley Holding Tool
AC	A0325	3387, 10020, T10004, T10020, U-30009, V159	Tensioner Pulley Adjusting Tool
AD	A0351	3418, T10098	Camshaft Setting Bar
AE	A0380	T10050, T10100	Crankshaft Sprocket Locking Tool
AF	A0381	T10050, T10100	Crankshaft Sprocket Locking Tool
AG	A0408		Tensioner Adjusting Tool
AH	A0453	3212	Pulley Holding Tool
AI	A0454	T10172-2, T10172-4	Camshaft Sprocket Holding Tool Pins

TOOL REFERENCE

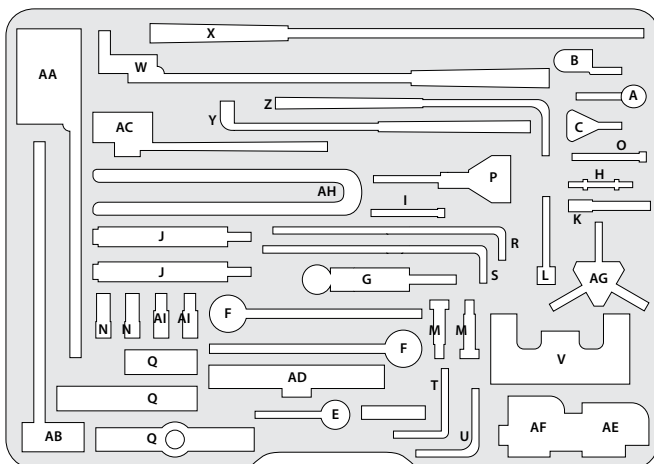

TIMING TOOL KIT

- Suitable for popular 1.4L – 1.6L DOHC 16V petrol engine applications
- For the locking and alignment of the camshafts, crankshaft and tensioner during the removal and installation of the engine timing belt, chain and other engine servicing and repairs



APPLICATION LIST*

Part No.	Make & Model	Engine	Year
304716	Audi		
	A1	1.4L	2010 - 2015
	A3	1.4L	2008 - 2013
	Skoda		
	Fabia	1.4L	2010 - 2015
	Octavia	1.4L	2010 - 2013
	Rapid	1.4L (CAXA)	2013 - 2015
	Roomster	1.6L (BTS)	2007 - 2015
	Yeti	1.4L (CAXA)	2014 - 2018
	Volkswagen		
	Beetle	1.4L (CTHD)	2013 - 2018
	Golf	1.4L, 1.6L	2004 - 2014
	Jetta	1.4L	2004 - 2017
	Polo	1.4L, 1.6L	2006 - 2014
	Scirocco	1.4L	2009 - 2010
	Tiguan	1.4L	2011 - 2016

CONTENTS

Tool Ref.	Toledo Tool No.	OEM Tool No.	Description
A	A0001	T40011	Tensioner Locking Pin
B	A0041	T10170	Adaptor - TDC Indicator
C	A0143	T10172-4	Camshaft Sprocket Holding Tool Pins
D	A0314	T10172	Universal Flange Holding Wrench
E	A0323	3415, T30004	Crankshaft Pulley Holding Tool
F	A0398	T10171, T10171A	Camshaft Alignment Tool
G	A0409	6079	Dial Gauge
H	A0631	T10340	Crankshaft Locking Tool
I	A0632	T10341	Tools - Guide Pins (2)

TOOL REFERENCE

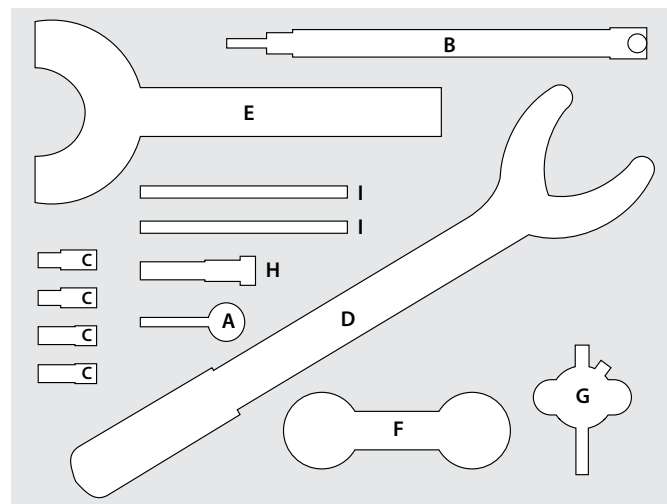

TIMING TOOL KIT  

- Suitable for popular 1.4L – 2.0L petrol and diesel engine applications
- For the locking and alignment of the camshafts, crankshaft and tensioner during the removal and installation of the engine timing belt, chain and other engine servicing and repairs



APPLICATION LIST*

Part No.	Make & Model	Engine	Year
304725	Audi		
	A3, A4, A6	1.8L, 2.0L	1997 - 2009
	A3, A4, A5, A6 (Diesel)	2.0L	2004 - 2018
	Q3	2.0L	2015 - 2018
	Q3, Q5 (Diesel)	2.0L	2009 - 2018
	TT	2.0L	2006 - 2015
	Skoda		
	Octavia (Diesel)	1.6L - 2.0L	2006 - 2014
	Roomster (Diesel)	1.9L	2007 - 2010
	Superb (Diesel)	2.0L	2008 - 2018
	Yeti (Diesel)	2.0L	2010 - 2017
	Volkswagen		
	Amarok (Diesel)	2.0L	2011 - 2018
	Beetle, EOS, Golf, Jetta, Passat, Polo	1.6L - 2.0L	1997 - 2013
	Beetle, EOS, Golf, Passat, Polo, Tiguan (Diesel)	1.6L - 2.0L	1995 - 2016
	Caddy, Citivan	1.6L, 2.0L	2006 - 2010
	Caddy, Citivan (Diesel)	1.6L - 2.0L	2004 - 2015
Multivan, Transporter (Diesel)	2.0L	2004 - 2018	
Scirocco	2.0L	2010 - 2017	
Multivan	2.0L	2004 - 2010	

CONTENTS

Tool Ref.	Toledo Tool No.	OEM Tool No.	Description
A	A0010		Locking Pin
B	A0011	T10115	Chain Tensioner Locking Pin
C	A0022	3359, MP 1-301	Camshaft Locking Tool
D	A0023	3411	Support Guides
E	A0024	T10093	Support Guides
F	A0043	M5 x 55mm	Stud and Nut
G	A0044		Set Screw M5 x 60mm
H	A0058	3369	Support Guides
I	A0111		Timing Pin
J	A0143	T10172-4	Camshaft Sprocket Holding Tool Pins
K	A0197	T10264	Tensioner Pulley Adjusting Tool
L	A0198	T10265, T40098	Auxiliary Drive Belt Tensioner Locking Pin
M	A0209	3204, T10060, T10060A	Auxiliary Drive Belt Tensioner Locking Pin
N	A0314	T10172	Universal Flange Holding Wrench
O	A0326	3387, 10020, T10004, T10020, U-30009, V159	Tensioner Pulley Adjusting Tool
P	A0380	T10100	Crankshaft Sprocket Locking Tool
Q	A0381	T10050	Crankshaft Sprocket Locking Tool
R	A0408		Tensioner Adjusting Tool

TOOL REFERENCE

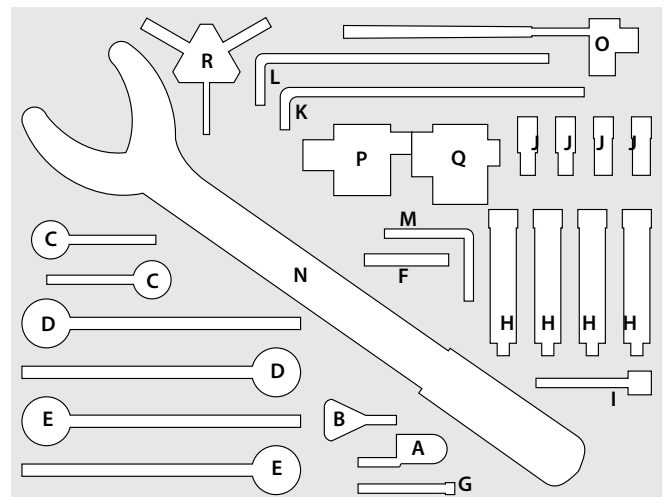

TIMING TOOL KIT

- Suitable for various 1.4L – 2.0L petrol engine models
- For the locking and alignment of the camshaft and crankshaft during the removal and installation of the engine timing belt, chain and other engine servicing and repairs



APPLICATION LIST*

Part No.	Make & Model	Engine	Year
304728	Audi		
	A2	1.4L, 1.6L	2001 - 2004
	A4	1.8L - 2.0L	1995 - 2008
	Volkswagen		
	Beetle	1.6L	2001 - 2011
	Caddy	1.6L	2004 - 2010
	Citivan	2.0L	2006 - 2010
	Golf	1.6L	1995 - 2009
	Passat	1.8L - 2.0L	1997 - 2005
	Polo	1.4L - 1.8L	2000 - 2014
	Transporter	2.0L	2004 - 2010

CONTENTS

Tool Ref.	Toledo Tool No.	OEM Tool No.	Description
A	A0025	T10016, T10074	Camshaft Locking Tool
B	A0043	M5 X 55MM	Stud and Nut
C	A0058	3369	Support Guides
D	A0210	3204, T10060, T10060A	Auxiliary Drive Belt Tensioner Locking Pin
E	A0322	T10028	Crankshaft Pulley Holding Tool
F	A0323	3415	Crankshaft Pulley Holding Tool
G	A0325	T10020	Two-Pin Wrench

TOOL REFERENCE

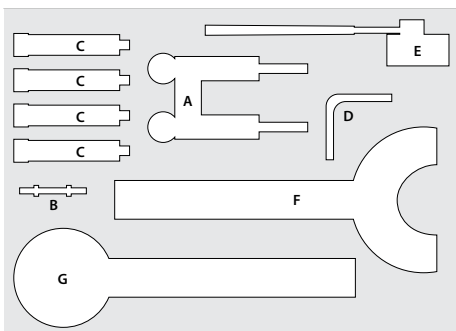

TIMING TOOL KIT

- Suitable for popular 2.7L & 3.0L (V6), 4.1L & 4.2L (V8) DOHC diesel engine applications
- For the locking and alignment of the camshafts, crankshaft and tensioner during the removal and installation of the engine timing chain and other engine servicing and repairs



APPLICATION LIST*

Part No.	Make & Model	Engine	Year
304735	Audi		
	A4	2.7L, 3.0L (TDi)	2005 - 2014
	A5	3.0L (TDi)	2008 - 2017
	A6	2.7L, 3.0L (TDi)	2004 - 2018
	A7	3.0L (TDi)	2011 - 2018
	A8	3.0L, 4.1L, 4.2L (TDi)	2006 - 2018
	Q5	3.0L (TDi)	2009 - 2016
	Q7	3.0L, 4.1L, 4.2L (TDi)	2006 - 2015
	SQ5	3.0L (TDi)	2013 - 2016
	Porsche		
	Cayenne	3.0L (TDi)	2010 - 2014
	Volkswagen		
	Touareg	3.0L, 4.2L (TDi)	2006 - 2018

CONTENTS

Tool Ref.	Toledo Tool No.	OEM Tool No.	Description
A	A0644	40071	Tensioner Locking Pin (2 X 3.3mm)
B	A0022	3359	Camshaft Locking Tool
C	A0639	3242	Crankshaft TDC Locking Screw
D	A0212	T40060	Camshaft Locking Pin
E	A0641	T40049	Crankshaft Turning Tool
F	A0640	T40058	Crankshaft Pulley Bolt Adaptor
G	A0642	T40061	Camshaft Alignment Locking Tool
H	A0643	T40062	Camshaft Sprocket Holding Tool

TOOL REFERENCE

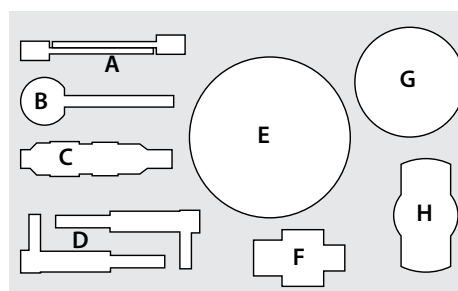

TIMING TOOL KIT  Petrol

- Suitable for various 1.8L and 2.0L DOHC 16V TFSi & 2.0L turbo petrol engine models
- For the locking and alignment of the camshaft, crankshaft and tensioner during the removal and installation of the engine timing chain and other engine servicing and repairs



APPLICATION LIST*

Part No.	Make & Model	Engine	Year
304750	Audi		
	A3, A4, A5, A6	1.8L - 2.0L	2007 - 2018
	Q3, Q5	2.0L	2009 - 2016
	TT	1.8L - 2.0L	2009 - 2018
	Skoda		
	Octavia	1.8L - 2.0L	2013 - 2018
	Volkswagen		
	Amarok	2.0L	2011 - 2016
	EOS	2.0L	2008 - 2016
	Golf	2.0L	2009 - 2018
	Jetta	2.0L	2009 - 2016
	Passat	1.8L - 2.0L	2008 - 2018
	Tiguan	2.0L	2008 - 2016

CONTENTS

Tool Ref.	Toledo Tool No.	OEM Tool No.	Description
A	A0041	T10170/A/1	Dial Gauge Adapter
B	A0667	T40265	Oil Pump Tensioner Locking Tool
C	A0666	T40196	Drifts For Camshaft Slide
D	A0675	T40266	Camshaft Adjuster Holding/Turning Tool
E	A0668	T10368	Crankshaft Pulley Bolt Spacer
F	A0660	T10352/1	Camshaft Adjuster Control Valve Removal Tool
G	A0751	T10352/2	Camshaft Adjuster Control Valve Removal Tool
H	A0002	T40011	Tensioner Locking Tool
I	A0662	T40271/1/2	Camshaft Locking Tool
I	A0663	T40271/1/2	Camshaft Locking Tool
J	A0665	T10355	Crankshaft Pulley Holding Tool
K	A0409	VAS 6079	Dial Gauge
L	A0664	T40267	Tensioner Locking Tool

TOOL REFERENCE

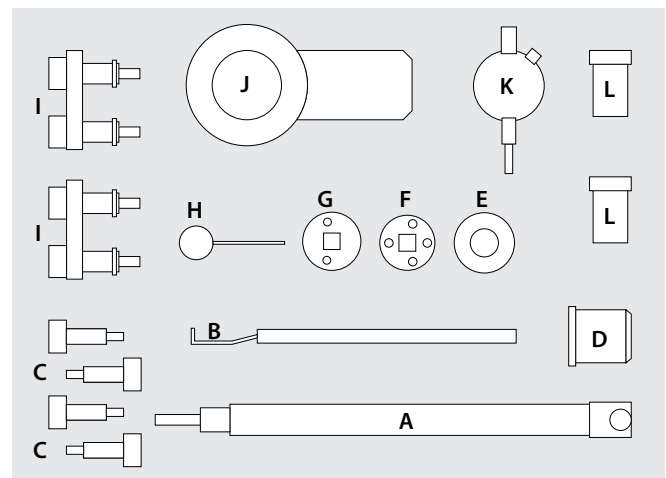

TIMING TOOL KIT

- Suitable for popular 2.3L – 6.0L DOHC V5, V6, W8, W12 petrol engine applications
- For the locking and alignment of the camshafts, crankshaft and fuel pump during the removal and installation of the engine timing chain and other engine servicing and repairs



APPLICATION LIST*

Part No.	Make & Model	Engine	Year
304756	Audi		
	A3 (8P)	3.2L	2004 - 2009
	Q7 (4L)	3.6L (BHK)	2006 - 2010
	TT	3.2L	2004 - 2010
	Porsche		
	Cayenne	3.6L (M55)	2007 - 2014
	Volkswagen		
	Bora (V5, V6)	2.3L - 2.8L	1999 - 2006
	Caravelle (V)	2.8L (AMV)	2002 - 2005
	Golf (IV)	2.8L - 3.2L	2001 - 2004
	Golf (V)	3.2L (BUB)	2006 - 2010
	Multivan (V)	3.2L (BKK)	2005 - 2008
	Passat (3B)	4.0L (BDN)	2002 - 2004
	Transporter (V)	3.2L (BKK)	2005 - 2008

CONTENTS

Tool Ref.	Toledo Tool No.	OEM Tool No.	Description
A	A0639	3242	Crankshaft TDC Locking Screw
B	A0732	T10332	High-Pressure Fuel Pump Sprocket Locking Tool
C	A0733	T10068 A	Camshaft Alignment Tool
D	A0734	T10363	High-Pressure Fuel Pump Sprocket Locking Tool

TOOL REFERENCE

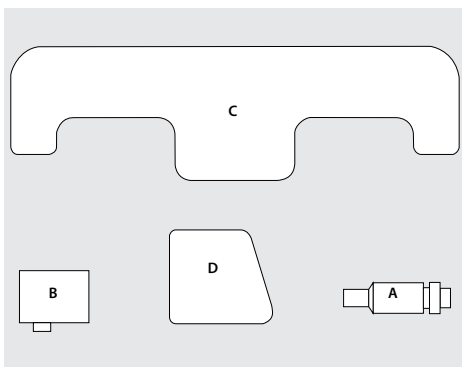

CAMSHAFT ALIGNMENT TOOL KIT

- Suits 3.0L V6, DOHC 30V petrol engines
- For the locking and alignment of the camshafts, crankshaft and tensioner during engine servicing and repairs



APPLICATION LIST*

Part No.	Make & Model	Engine	Year
304036	Audi		
	A4 (V6)	3.0L (ASN)	2001 - 2004
	A4 (V6)	3.0L (BBJ)	2001 - 2005
	A6 (V6)	3.0L (ASN)	2001 - 2004
	A6 (V6)	3.0L (BBJ)	2002 - 2005

CONTENTS

Tool Ref.	Toledo Tool No.	OEM Tool No.	Description
A	A0001	T40011	Tensioner Locking Pin
B	A0152	T40028	Camshaft Sprocket Adjusting Tool
C	A0173	T40026	Crankshaft Locking Tool
D	A0289	T40030	Camshaft Locking Tools
E	A0318	3387	Tensioner Pulley Adjusting Tool

TOOL REFERENCE

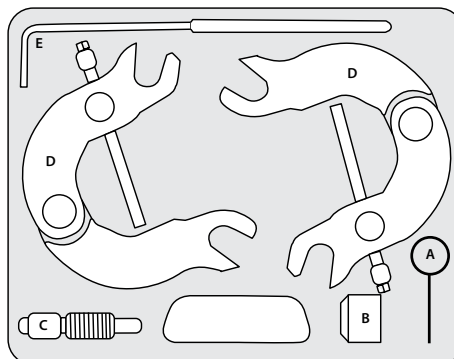

TIMING TOOL KIT 

- Suitable for popular VAG 1.0L, 1.2L and 1.4L petrol engine applications
- For the locking and alignment of the camshafts and crankshaft during the removal and installation of the engine timing belt and other engine servicing and repairs



APPLICATION LIST*

Part No.	Make & Model	Engine	Year
304757	Audi		
	A1	1.2L - 1.4L	2012 - 2018
	A3	1.4L (DOHC)	2013 - 2016
	Q3	1.4L (CHP, CZE)	2014 - 2018
	Skoda		
	Fabia	1.2L	2010 - 2018
	Octavia	1.4L (CHP)	2013 - 2015
	Yeti	1.2L (CBZB)	2011 - 2018
	Volkswagen		
	Caddy	1.2L (CBZ)	2010 - 2015
	Golf (VI)	1.2L (SOHC)	2010 - 2015
	Golf (VII)	1.4L (DOHC)	2013 - 2018
	Polo (6R)	1.2L	2010 - 2018
	UP!	1.0L (CHY)	2012 - 2018

CONTENTS

Tool Ref.	Toledo Tool No.	OEM Tool No.	Description
A	A0631	T10340	Crankshaft Locking Bolt
B	A0691	T10477	Camshaft Setting Plate
C	A0692	T10476	Camshaft Sprocket Locking Tool
D	A0693	T10499	Tensioner Adjusting Wrench
E	A0694	T10494	Camshaft Setting Plate
F	A0695	T10487	Assembly Tool
G	A0669	T10414	Camshaft Alignment Tool
H	A0197	T10264	Tensioner Pulley Adjusting Tool
I	A0696	T10504	Camshaft Timing Tool
J	A0697	T10504/1	Camshaft Timing Tool Locking Pin
K	A0698	T10504/2	Camshaft Timing Check Pin

TOOL REFERENCE

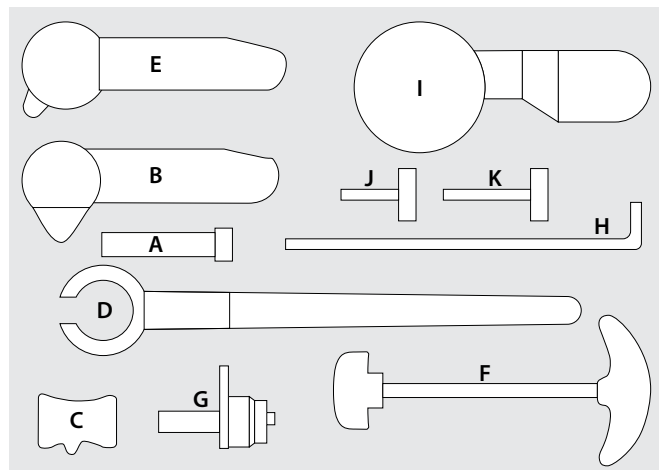

TIMING TOOL KIT

- Suitable for popular VAG 1.6L and 2.0L DOHC 16V diesel engine applications
- For the locking and alignment of the camshafts, crankshaft and fuel pump during the removal and installation of the engine timing belt and other engine servicing and repairs



APPLICATION LIST*

Part No.	Make & Model	Engine	Year
304765	Audi		
	A3 (8V)	1.6L (CLH)	2013 - 2014
	A3 (8V)	2.0L (CRBC)	2013 - 2016
	A3 (8V)	2.0L (CRLB)	2013 - 2016
	A4 (8K)	2.0L (CNH)	2014 - 2016
	Skoda		
	Octavia (NE)	1.6L (CLH)	2013 - 2018
	Octavia (NE)	2.0L (CKF)	2013 - 2018
	Octavia (NE)	2.0L (CUN)	2014 - 2018
	Octavia (NE)	2.0L (CUP)	2013 - 2018
	Volkswagen		
	Golf (VII)	1.6L (CLH)	2013 - 2018
	Golf (VII)	2.0L (CRBC)	2013 - 2018

CONTENTS

Tool Ref.	Toledo Tool No.	OEM Tool No.	Description
A	A0022	3359	Camshaft Locking Tools
B	A0197	T10264, T10409	Tensioner Pulley Adjusting Tool
C	A0198	T10265, T40098	Auxiliary Drive Belt Tensioner Locking Pin
D	A0210	T10060A	Auxiliary Drive Belt Tensioner Locking Pin
E	A0207	T10492	Injection Pump Timing Pins
F	A0704	T10490	Crankshaft Sprocket Locking Tool
G	A0705	T10051	High-Pressure Fuel Pump Sprocket Holding Tool

TOOL REFERENCE

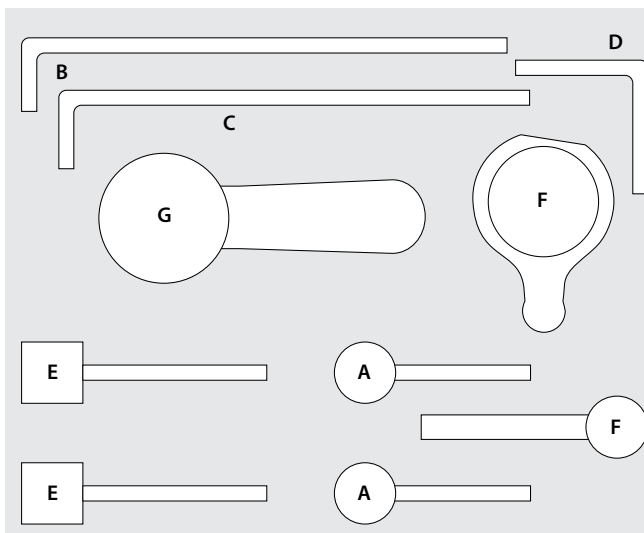

TIMING TOOL KIT 

- Suitable for popular 2.5L – 5.2L DOHC 5, V6, V8, V10 petrol engine applications
- For the locking and alignment of the camshafts, crankshaft and fuel pump during the removal and installation of the engine timing chain and other engine servicing and repairs



APPLICATION LIST*

Part No.	Make & Model	Engine	Year
304767	Audi		
	A4 (B7)	3.1L (AUK)	2005 - 2009
	A4 (B8)	3.2L (CALA)	2008 - 2012
	A5 (8T)	3.2L (CALA)	2007 - 2012
	A6 (C6)	2.8L - 3.1L	2005 - 2011
	A8 (D3)	4.2L	2005 - 2013
	Q5 (8R)	3.2L (CALB)	2009 - 2012
	Q7 (4L)	4.2L (BAR)	2006 - 2010
	R8 (4.2 FSI Quattro)	4.2L (BYH)	2007 - 2018
	R8	5.2L	2009 - 2018
	RS Q3 (8U)	2.5L (CTSA)	2014 - 2015
	RS4 (B7)	4.2L (BNS)	2006 - 2008
	RS5 (8F)	4.2L (CFS)	2010 - 2018
	TT RS (8J)	2.5L (CEPA)	2009 - 2013

CONTENTS

Tool Ref.	Toledo Tool No.	OEM Tool No.	Description
A	A0172	T40069	Crankshaft Locking Pin
B	A0454	T10172/2	Camshaft Sprocket Holding Tool Pins
C	A0455	T40070	Camshaft Locking Tools
D	A0456	T40071	Timing Chain Tensioner Locking Pins
E	A0618	T10172	Camshaft Sprocket Holding Tool
F	A0639	3242	Crankshaft TDC Locking Screw
G	A0640	T40058	Crankshaft Pulley Bolt Adaptor
H	A0641	T40049	Crankshaft Turning Tool
I	A0741	T40079	Camshaft Adjuster Holding Tool
J	A0742	T40133	Camshaft Locking Tools

TOOL REFERENCE

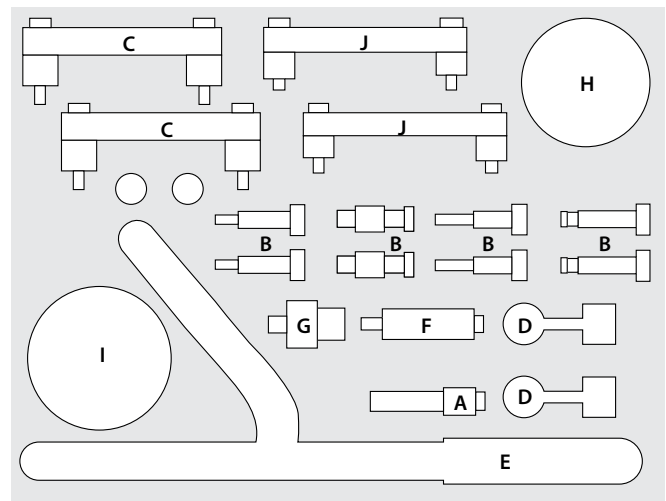

CAMSHAFT LOCKING KIT

- Suitable for popular 2.5L (N52) & 3.0L (N54 & N55) DOHC 24V engine applications with timing chains
- For the locking and alignment of the camshaft and crankshaft during the removal and installation of the engine timing chain and other engine servicing and repairs
- Required for dismantling, assembly and timing of the Vanos unit



APPLICATION LIST*

Part No.	Make & Model	Engine	Year
304700	BMW		
	1 Series (E82 - E88)	3.0L (N52, N54)	2005 - 2015
	3 Series (E90 - E93)	2.5L (N52B25)	2005 - 2014
	3 Series (E90 - E93)	3.0L (N52, N54, N55)	2005 - 2018
	435i (F32, F36)	3.0L (N55B30A)	2013 - 2016
	5 Series (E60 - E61)	2.5L, 3.0L (N52)	2004 - 2011
	5 Series (F07 - F11)	3.0L (N52, N55)	2010 - 2018
	M135i, M235i	3.0L (N55B30A)	2012 - 2018
	X1, X3, X5	3.0L (N52B30)	2006 - 2012
	X4, X5, X6	3.0L (N54, N55)	2008 - 2018
	Z4 (E85, E89)	2.5L, 3.0L (N52, N54)	2006 - 2018

CONTENTS

Tool Ref.	Toledo Tool No.	OEM Tool No.	Description
A	A0054	Bolts	Camshaft Alignment Tool Bolts
B	A0170	11 9 340	Timing Chain Pre-Tensioning Tool
C	A0232	11 0 300	Flywheel Timing Pin
D	A0266	11 4 281, 11 4 282, 11 4 283	Camshaft Alignment Tool
E	A0399	11 4 290	Camshaft Position (CMP) Sensor Disc Setting Tool
F	A0634	11 8 520	Camshaft Position (CMP) Sensor Disc Setting Tool
G		Bolts	Camshaft Alignment Tool Bolts
H		Bolts	Camshaft Alignment Tool Bolts
I		Bolts	Camshaft Alignment Tool Bolts

TOOL REFERENCE

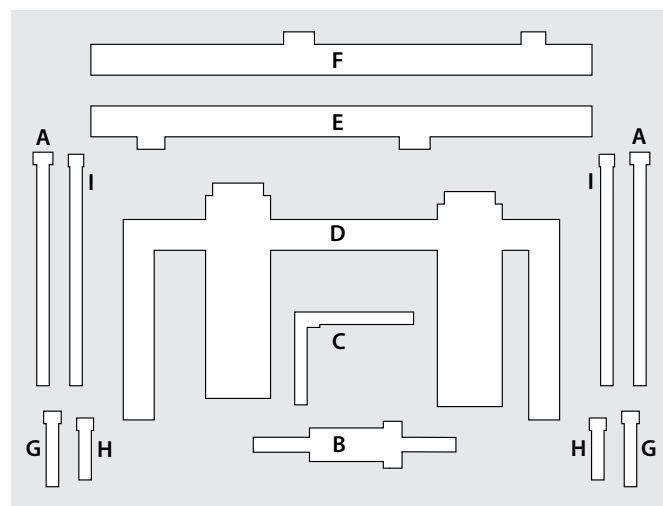

TIMING TOOL KIT

- Suitable for engine codes M42, M43, M44, M50, M52 & M54
- For the locking and alignment of the camshaft and crankshaft during the removal and installation of the engine timing chain and other engine servicing and repairs
- Required for dismantling, assembly and timing of the Vanos unit



APPLICATION LIST*

Part No.	Make & Model	Engine	Year
304701	BMW		
	3 Series (E36)	1.6L - 2.8L (M42, M43, M44, M50, M52)	1991 - 2001
	3 Series (E46)	1.9L - 3.0L (M43, M44, M52, M54)	1998 - 2007
	5 Series (E34)	2.0L, 2.5L (M50)	1990 - 1996
	5 Series (E39)	2.2L - 3.0L (M52, M54)	1996 - 2003
	5 Series (E60)	2.5L - 3.0L (M52, M54)	2003 - 2005
	7 Series (E38)	2.8L (M52B28)	1995 - 2001
	7 Series (E65)	3.0L (N52B30)	2002 - 2005

CONTENTS

Tool Ref.	Toledo Tool No.	OEM Tool No.	Description
A	A0003	11 3 290, 11 3 292	Tensioner Locking Tool
B	A0009	11 3 310	Secondary Tensioner Locking Tool
C	A0042	11 2 300	Crankshaft Locking Pin
D	A0161	11 8 210	Crankshaft Pulley Hub Puller
E	A0167	11 3 390, 11 4 220	Timing Chain Pre-Tensioning Tool
F	A0267	11 3 190	Camshaft Alignment Tool
G	A0275	11 3 240, 11 3 244	Camshaft Alignment Tool
H	A0280	11 9 110	Camshaft Locking Fixture Add-On
I	A0334	11 3 450	Vanos Unit Checking Tool
J	A0337	11 5 490	Exhaust Camshaft Sprocket Tool
K	A0400	11 6 180	Camshaft Sprockets Alignment Tool
L	A0426	11 6 150	Camshaft Timing Setting Tool
M	A0603	11 8 190	Vibration Damper Holder
N	A0604	11 8 200	Vibration Damper Puller Head

TOOL REFERENCE

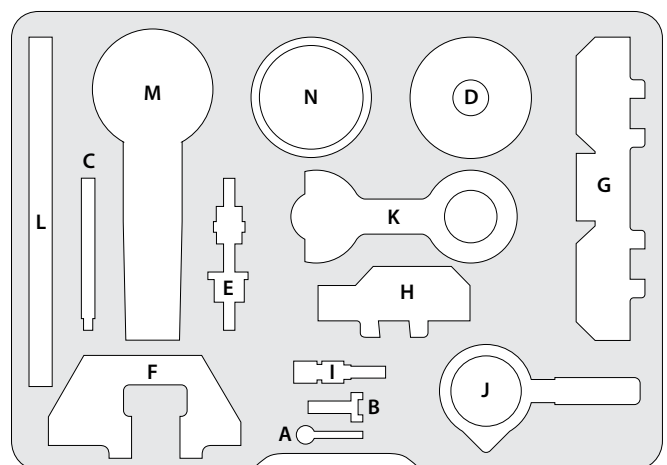

TIMING & ALIGNMENT TOOL KIT

- Suitable for popular 1.8L and 2.0L DOHC 16V N42 and N46 petrol engine applications
- For the locking and alignment of the camshaft and crankshaft during the removal and installation of the engine timing chain and other engine servicing and repairs
- Required for dismantling, assembly and timing of the Vanos unit



APPLICATION LIST*

Part No.	Make & Model	Engine	Year
304702	BMW		
	1 Series (E87)	2.0L (N46B20)	2004 - 2011
	3 Series (E46)	1.8L (N42B18)	2001 - 2005
	3 Series (E46)	2.0L (N42B20)	2001 - 2005
	3 Series (E46)	2.0L (N46B20)	2001 - 2005
	3 Series (E90)	2.0L (N42B20)	2005 - 2007
	3 Series (E90 - E93)	2.0L (N46B20)	2005 - 2012

CONTENTS

Tool Ref.	Toledo Tool No.	OEM Tool No.	Description
A	A0042	11 5 120	Crankshaft Locking Pin
B	A0115	11 9 293	Camshaft Alignment Tool Bolt (M8 X 25mm)
C	A0150	11 9 270	Inlet Camshaft Turning Tool
D	A0170	11 9 340	Timing Chain Pre-Tensioning Tool
E	A0214	11 5 120, 11 9 190	Flywheel Timing Pin
F	A0281	11 9 291	Camshaft Alignment Tool - Exhaust
G	A0354	11 9 292	Camshaft Alignment Tool - Inlet
H	A0424	11 9 350	Sensor Gear Alignment Tool

TOOL REFERENCE

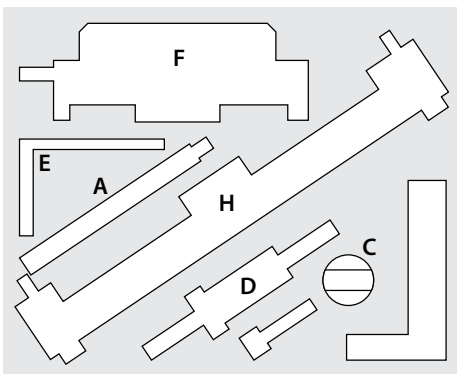

TIMING TOOL KIT

- Suitable for popular 2.0L (N47 & N57) DOHC 16V diesel engine applications
- For the locking and alignment of the camshafts, crankshaft, tensioner and injection pump during the removal and installation



APPLICATION LIST*

Part No.	Make & Model	Engine	Year	
304719	BMW			
	118d, 120d, 123d	2.0L (N47)	2007 - 2015	
	220d (F22)	2.0L (B47, N47)	2014 - 2018	
	318d, 320d	2.0L (N47D)	2007 - 2017	
	330d	3.0L (N57D30)	2009 - 2018	
	420d	2.0L (N47D20C)	2013 - 2016	
	520d	2.0L (N47)	2007 - 2018	
	530d, 535d	3.0L (N57D30)	2009 - 2017	
	640d, 730d	3.0L (N57D30)	2009 - 2018	
	X1, X3, X5	2.0L (N47D20)	2007 - 2015	
	X3, X4, X5, X6	3.0L (N57D30)	2010 - 2018	
	MINI			
	Cooper (D)	1.6L, 2.0L (N47)	2010 - 2018	
Countryman (D)	1.6L, 2.0L (N47)	2011 - 2018		

CONTENTS

Tool Ref.	Toledo Tool No.	OEM Tool No.	Description
A	A0004	11 3 340	Chain Tensioner Lock Pin
B	A0053	11 3 340	Timing Chain Tensioner Locking Pin
C	A0457	11 6 480	Crankshaft Alignment Tool
D	A0458	11 5 320	Flywheel/Drive Plate Timing Pin
E	A0459	11 6 480	Socket
F	A0460	11 8 760	Camshaft Alignment Tool
G	A0612	11 8 740	High-Pressure Fuel Pump Sprocket Removal Tool

TOOL REFERENCE

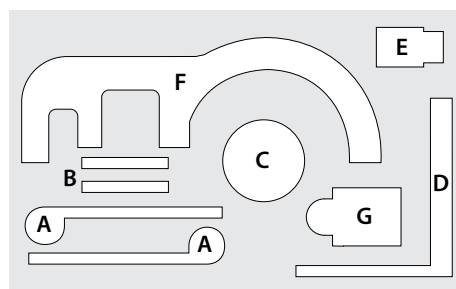

TIMING TOOL KIT 

- Suitable for popular 2.0L (N43B20) DOHC 16V engine applications with timing chains.
- For the locking and alignment of the camshafts, crankshaft and tensioner during the removal and installation of the engine timing chain and other engine servicing and repairs
- Required for dismantling, assembly and timing of the Vanos unit



APPLICATION LIST*

Part No.	Make & Model	Engine	Year
304740	BMW		
	118i (E87)	2.0L (N43B20)	2008 - 2010
	120i (E82)	2.0L (N43B20)	2011 - 2014
	120i (E87)	2.0L (N43B20)	2007 - 2011
	120i (E88)	2.0L (N43B20)	2007 - 2015

CONTENTS

Tool Ref.	Toledo Tool No.	OEM Tool No.	Description
A	A0004	11 3 340	Chain Tensioner Lock Pin
B	A0170	11 9 340	Timing Chain Pre-Tensioning Tool
C	A0214	11 5 120	Flywheel Timing Pin
D	A0527	11 8 711, 11 8 712	Camshaft Position (CMP) Sensor Disc Setting Tool
E	A0528	11 8 690, 11 8 691, 11 8 962, 11 8 693	Camshaft Alignment Tool
F	A0529	11 8 700	Balancer Shaft Alignment Tool

TOOL REFERENCE

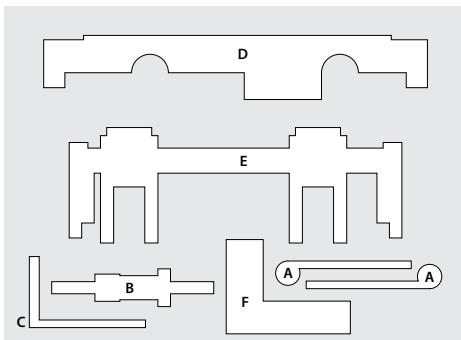

TIMING TOOL KIT 

- Suitable for popular BMW and Mini 1.6L DOHC 16V (N13 / N18) petrol engine applications
- For the locking and alignment of the camshafts and crankshaft during the removal and installation of the engine timing chain and other engine servicing and repairs



APPLICATION LIST*

Part No.	Make & Model	Engine	Year
304758	BMW		
	116i, 118i, 120i (F20)	1.6L (N13)	2011 - 2018
	316i (F30)	1.6L (N13B)	2013 - 2018
	MINI		
	Cooper (JCW, S)	1.6L (N18B16A)	2012 - 2018
	Countryman (JCW, S)	1.6L (N18B16A)	2011 - 2017

CONTENTS

Tool Ref.	Toledo Tool No.	OEM Tool No.	Description
A	A0170	11 9 340	Timing Chain Pre-Tensioning Tool
B	A0208	11 9 590, 0 496 709	Crankshaft Timing Pin
C	A0699	2 299 362	Crankshaft Timing Pin
D	A0700	11 7 440	Camshaft Alignment Tool
E			Bolts

TOOL REFERENCE

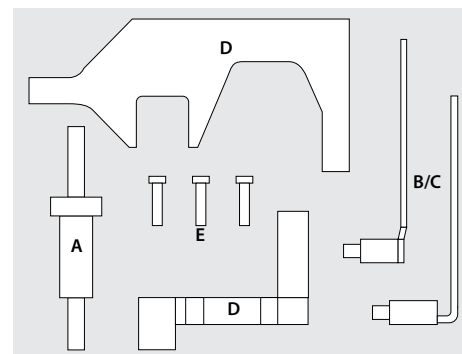

TIMING TOOL KIT

- Suitable for popular 3.6L – 4.8L (V8) DOHC 32V and 6.0L (V12) DOHC 48V petrol engine applications
- For the locking and alignment of the camshafts, crankshaft and tensioner during the removal and installation of the engine timing chain and other engine servicing and repairs



APPLICATION LIST*

Part No.	Make & Model	Engine	Year
304724	BMW		
	540i (E60)	4.0L (N62B40)	2005 - 2008
	545i (E60)	4.4L (N62B44)	2003 - 2006
	550i (E60, E61)	4.8L (N62B48)	2005 - 2010
	645Ci (E63, E64)	4.4L (N62B44)	2004 - 2005
	650i (E63, E64)	4.8L (N62B48)	2005 - 2012
	735i, Li (E65, E66)	3.6L (N62B36)	2002 - 2005
	740i, Li (E65, E66)	4.0L (N62B40)	2005 - 2009
	745i, Li (E65, E66)	4.4L (N62B44)	2002 - 2005
	750i, Li (E65, E66)	4.8L (N62B48)	2005 - 2009

CONTENTS

Tool Ref.	Toledo Tool No.	OEM Tool No.	Description
A	A0165	11 9 463	Camshaft Locking Tool
B	A0170	11 9 340, 11 9 341	Timing Chain Pre-Tensioning Tool
C	A0214	11 9 190	Flywheel Timing Pin
D	A0264	11 9 461	Inlet Camshaft Alignment Tool
E	A0265	11 9 462	Exhaust Camshaft Alignment Tool
F	A0605	11 9 451	Crankshaft Locking Tool
G	A0606	11 9 452	Crankshaft Locking Tool
H	A0635		Head Cylinder Socket
I	A0636		Angle Indicator
J	A0637		Socket (27mm)
K	A0638		Angle Gauge

TOOL REFERENCE

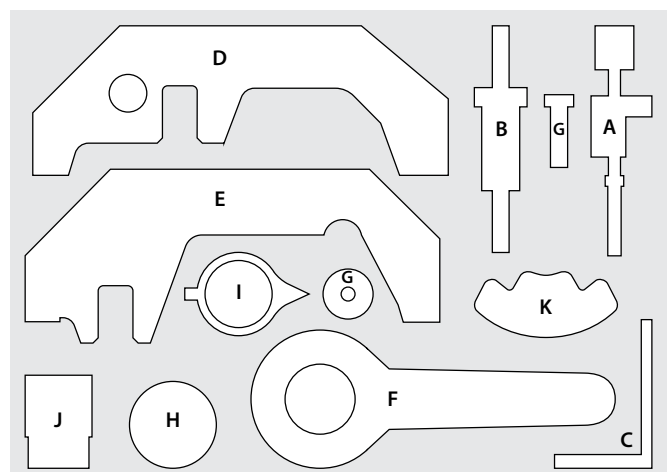

TIMING TOOL KIT  Diesel

- Suitable for popular 2.0L (M47) DOHC 16V and 3.0L (M57) DOHC 24V diesel engine applications
- For the locking and alignment of the camshafts, crankshaft, tensioner and injection pump during the removal and installation of the engine timing chain and other engine servicing and repairs



APPLICATION LIST*

Part No.	Make & Model	Engine	Year
304741	BMW		
	120d (E87)	2.0L (M47TUD20)	2006 - 2007
	320d (E46, E90 - E91)	2.0L (M47D20)	1999 - 2008
	330d (E46, E90 - E91)	3.0L (M57D30)	2000 - 2008
	335d (E90 - E92)	3.0L (M57D30)	2007 - 2010
	525d (E60, E61)	3.0L (M57D30)	2007 - 2010
	530d (E39)	3.0L (M57D30)	2000 - 2003
	530d (E60)	3.0L (M57D30)	2008 - 2010
	530d (E60, E61)	3.0L (M57TUD30)	2003 - 2008
	535d (E60, E61)	3.0L (M57D30)	2004 - 2010
	X3 (E83)	2.0L (M47TUD20)	2005 - 2007
	X3 (E83)	3.0L (M57TUD30)	2005 - 2011
	X5 (E53)	3.0L (M57D30)	2001 - 2003
	X5 (E70)	3.0L (M57TU2D30)	2004 - 2010
	X6 (E71)	3.0L (M57TU2D30)	2008 - 2010

CONTENTS

Tool Ref.	Toledo Tool No.	OEM Tool No.	Description
A	A0004	11 3 340	Chain Tensioner Lock Pin
B	A0042	11 2 300	Crankshaft Locking Pin
C	A0053	11 3 340	Timing Chain Tensioner Locking Pin
D	A0154	13 5 190, 13 5 191	High-Pressure Fuel Pump Sprocket Puller
E	A0177	11 6 320, 11 6 321	Camshaft Alignment Tool
F	A0212	11 5 180, 11 6 080	Camshaft Locking Pin
G	A0269	11 6 321, 11 6 322	Camshaft Alignment Tool
H	A0457	11 6 480	Crankshaft Alignment Tool
I	A0459	11 6 480	Socket

TOOL REFERENCE

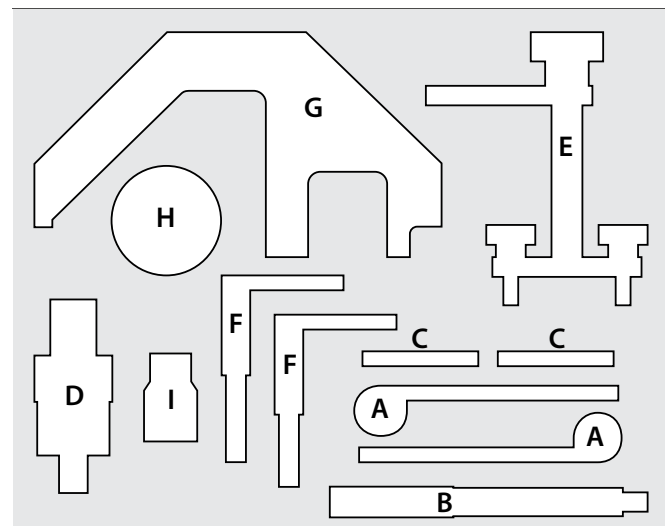

CAMSHAFT LOCKING KIT

- Suitable for popular 2.0L (N20B20) DOHC 16V petrol engine applications with timing chains
- For the locking and alignment of the camshafts, crankshaft and tensioner during the removal and installation of the engine timing chain and other engine servicing and repairs



APPLICATION LIST*

Part No.	Make & Model	Engine	Year
304759	BMW		
	125i (F20)	2.0L (N20B20A)	2012 - 2015
	220i, 228i (F22, F23)	2.0L (N20B20A)	2014 - 2018
	320i, 328i (F30, F31, F34)	2.0L (N20B20)	2012 - 2018
	420i, 428i (F32, F33, F36)	2.0L (N20B20B)	2013 - 2016
	520i (F10, F11)	2.0L (N20B20B)	2011 - 2017
	X1, X3, X4	2.0L (N20B20A)	2011 - 2018
	Z4 (E89)	2.0L (N20B20)	2011 - 2018

CONTENTS

Tool Ref.	Toledo Tool No.	OEM Tool No.	Description
A	A0170	11 9 340	Timing Chain Pre-Tensioning Tool
B	A0701	2 212 830	Sensor Gear Alignment Tool
C	A0702	2 212 831	Camshaft Alignment Tool
D	A0703	2 219 548	Flywheel/Drive Plate Timing Pin

TOOL REFERENCE

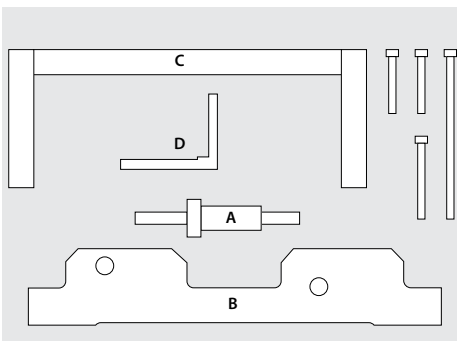

TIMING TOOL KIT

- Suitable for popular BMW & MINI 1.2L, 1.5L (B38) & 2.0L (B48) engine applications
- For the locking of the camshafts and crankshaft during the removal and installation of the engine timing chain and other engine servicing and repairs

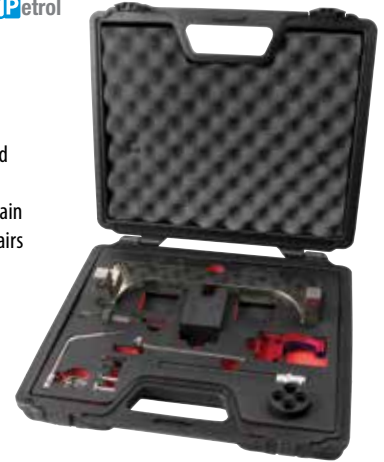

APPLICATION LIST*

Part No.	Make & Model	Engine	Year
304763	BMW		
	218i (F45)	1.5L (B38A15M)	2014 - 2018
	i8 (I12)	1.5L (B38K15A)	2014 - 2018
	MINI		
	Cooper	1.5L (B38A15M)	2014 - 2018
	Cooper S	2.0L (B48A20A)	2014 - 2018
	One	1.2L (B38A12U)	2014 - 2018

CONTENTS

Tool Ref.	Toledo Tool No.	OEM Tool No.	Description
A	A0170	11 9 340	Timing Chain Pre-Tensioning Tool
B	A0457	11 6 480	Crankshaft Alignment Tool
C	A0739	2 358 122	Camshaft Alignment Tool
D	A0740	2 288 380	Flywheel/Drive Plate Timing Pin
E	A0750	2 365 488	Drive Plate Timing Pin Adapter
F	A0759	2 360 895	Pin Wrench
G	A0760	11 8 580	Socket Wrench T60

TOOL REFERENCE

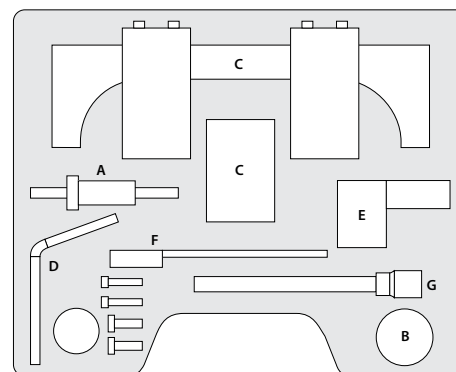

FLYWHEEL LOCKING TOOL

- Suitable for popular late model BMW applications
- For the locking the flywheel (crankshaft) during the removal and installation of the engine timing belt or other engine servicing and repairs



APPLICATION LIST*

Part No.	Make & Model	Engine	Year
304774	BMW		
	1 Series (E87)	1.6L (N45B16)	2005 - 2008
	1 Series (E87)	2.0L (M47, N46)	2004 - 2012
	1 Series (E82, E87)	3.0L (N52, N54)	2008 - 2012
	3 Series (E46, E90 - E93)	2.0L (N46)	2001 - 2012
	3 Series (E46, E90 - E93)	2.5L (N52)	2006 - 2012
	3 Series (E90 - E93)	3.0L (N52, N54)	2005 - 2012
	5 Series (E60)	2.5L (N52)	2005 - 2010
	5 Series (E60, E61, F10)	3.0L (M57, N52)	2003 - 2012
	7 Series (E65, F01 - F02)	3.0L (N52, N54)	2002 - 2012
	X1 (E84)	3.0L (N52B30)	2010 - 2012
	X3 (E83)	2.0L (M47TUD20)	2005 - 2007
	X3 (E83, F25)	2.5L, 3.0L (M57, N52B, N53B)	2005 - 2012
	X5 (E70)	3.0L (M57, N52)	2007 - 2010
	X6 (E71)	3.0L (N54B30)	2008 - 2012
	Z4 (E85, E89)	2.5L, 3.0L (N52B, N54B)	2006 - 2012

FLYWHEEL LOCKING TOOL

- Suitable for popular late model BMW applications including, 1 to 6 Series models, as well various X Series applications 2007 – on
- For the locking the flywheel (crankshaft) during the removal and installation of the engine timing belt, chain and other engine servicing and repairs
- OEM reference No. 11 9 260



APPLICATION LIST*

Part No.	Make & Model	Engine	Year
304785	BMW		
	118d, 120d, 123d	2.0L (N47)	2007 - 2015
	318d, 320d	2.0L (N47)	2008 - 2015
	330d	3.0L (N57D30)	2009 - 2018
	420d, 520 d	2.0L (N47)	2007 - 2018
	X1, X3, X5	2.0L (N47)	2007 - 2015
	X3	2.0L (B47D40A)	2011 - 2018
	X3, X4, X5, X6	3.0L (N57)	2010 - 2018

TOOL REFERENCE

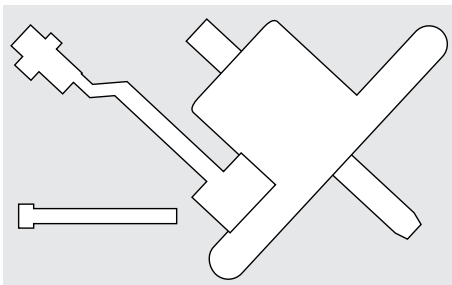

TIMING TOOLS

CHRYSLER/DODGE

Also suitable: Part No. 304749

TIMING TOOL KIT



- Suitable for Chrysler Grand Voyager (RT) & Dodge Nitro (KA) 2.8L diesel engine applications
- For full kit contents refer to page 157



CITROËN

Also suitable: Part No. 304704

TIMING TOOL KIT



- Suitable for popular Citroën 1.4L – 2.2L petrol and 1.5L – 2.2L diesel engine applications
- For full kit contents refer to page 171



Also suitable: Part No. 304718

TIMING TOOL KIT



- Suitable for popular Citroën C3, C4 and DS3, 1.4L – 1.6L (DOHC) petrol engine applications
- For full kit contents refer to page 173



Also suitable: Part No. 304721

TIMING TOOL KIT



- Suitable for popular Citroën C4, C5, Dispatch & Xsara 2.0L & 2.2L diesel engine applications
- For full kit contents refer to page 172



Also suitable: Part No. 304726

TIMING TOOL KIT



- Suitable for popular Citroën Berlingo, C2, C3 and C4 petrol engine applications
- For full kit contents refer to page 173



FIAT

Also suitable: Part No. 304705

TIMING & ALIGNMENT TOOL MASTER KIT



- Suitable for popular Fiat 500, Punto, Ritmo applications
- For full kit contents refer to page 123



Also suitable: Part No. 304712

TIMING TOOL MASTER KIT



- Suitable for popular Fiat Bravo, Doblo, Freemont & Ritma diesel engine applications
- For full kit contents refer to page 154



Also suitable: Part No. 304720

TIMING TOOL KIT



- Suitable for popular Fiat Bravo, Doblo, Freemont, Multipla, Punto & Ritma diesel engine applications
- For full kit contents refer to page 122



Scan here for link to part finder

TIMING TOOL KIT



- Suitable for popular 1.4L – 2.5L DOHC petrol and 1.6L – 2.0L diesel engine applications
- For the locking of the camshaft, crankshaft and tensioners during the removal and installation of the engine timing belt or chain along with other engine servicing and repairs



APPLICATION LIST*

Part No.	Make & Model	Engine	Year
304706	Ford		
	Escape (ZB - ZD)	2.3L (L3)	2004 - 2012
	Escape (WS - WZ)	1.4L - 2.0L	2004 - 2014
	Focus (LR - LW)	1.6L - 2.0L	2000 - 2015
	Kuga (TF)	2.0L (TXMA)	2013 - 2016
	Mondeo (MA - MD)	2.0L, 2.3L	2007 - 2018
	Ranger (PX)	2.5L (DPAT)	2011 - 2015
	Mazda		
	CX-7 (ER)	2.3L, 2.5L	2006 - 2012
	Mazda 3 (BK - BL)	2.0L - 2.5L	2004 - 2014
	Mazda 6 (GG - GY)	2.0L - 2.5L	2002 - 2012
	MX5	2.0L (MZR)	2005 - 2015
	Tribute	2.0L, 2.3L	2001 - 2008

CONTENTS

Tool Ref.	Toledo Tool No.	OEM Tool No.	Description
A	A0011	303-1054	Chain Tensioner Locking Pin
B	A0081		Locking Pin
C	A0089	21-262, 303-734, 999 7121	Crankshaft Locking Pin
D	A0092	21-263, 303-735, 999 7122	Camshaft Locking Pin
E	A0107	07744-0010400, 21-2160, 303-732, 999 7169, 999 7233	Camshaft Timing Pins
F	A0121	303-748	Crankshaft Alignment Pin
G	A0122	21-210, 303-507, 49 JE01 061	Camshaft Timing Pin
H	A0124	21-163, 303-620	Crankshaft Timing Pin
I	A0216	303-1059, 999 7121	Flywheel Timing Pin
J	A0257	303-1061, 49 UN30 310610	Camshaft Alignment Tool
K	A0361	303-1097	Camshaft Sprocket Locking Tool
L	A0406	303-393, 999 7119	Flywheel Locking Tool
M	A0418	21-162, 303-376, 49 JE01 054	Camshaft Setting Bar
N	A0435	303-393-01, 303-393-02, 999 7120	Flywheel Locking Tool Adaptors
O	A0608	49 B011 105	Crankshaft Pulley Holding Tool
P	A0618		Universal Sprocket Holding Tool

TOOL REFERENCE

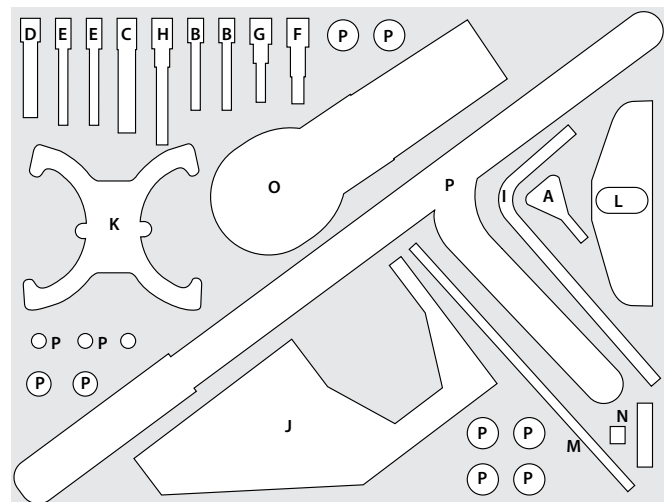

TIMING TOOL KIT



- Suitable for popular 1.4L – 2.5L DOHC petrol and 1.6L – 3.2L diesel engine applications
- For the locking of the camshaft, crankshaft and tensioners during the removal and installation of the engine timing belt or chain along with other engine servicing and repairs



APPLICATION LIST*

Part No.	Make & Model	Engine	Year
304708	Ford		
	Ecosport (BK)	1.5L (1.5)	2013 - 2017
	Escape (ZB - ZD)	2.3L (L3)	2004 - 2012
	Fiesta (WP - WZ)	1.5L - 2.0L	2004 - 2014
	Fiesta (WS - WT)	1.6L (Diesel)	2009 - 2013
	Focus (LR)	1.6L, 1.8L	2000 - 2005
	Focus (LR - LV)	2.0L	2000 - 2011
	Focus (LT - LV)	2.0L (D4204T)	2007 - 2011
	Focus (LW)	2.0L - 1.6L	2011 - 2015
	Kuga (TF)	2.0L (TXMA)	2013 - 2016
	Mondeo (HA - HE)	2.0L	1995 - 2000
	Mondeo (MA - MC)	2.3L	2007 - 2015
	Mondeo (MA - MD)	2.0L Diesel	2007 - 2018
	Ranger (PJ, PK)	2.5L (WL-AT)	2007 - 2011
	Ranger (PJ, PK)	3.0L (WE-AT)	2007 - 2011
	Ranger (PX)	2.2L (P4AT)	2011 - 2016
	Ranger (PX)	3.2L (P5AT)	2015 - 2018
	Transit (Diesel)	2.4L, 2.5L	1994 - 2012
	Mazda		
	BT50 (UN)	2.5L (WL-AT)	2006 - 2011
	BT50 (UN)	3.0L (WEAT)	2006 - 2011
	BT50 (UP, UR)	2.2L (P4AT)	2011 - 2016
	BT50 (UP, UR)	3.2L (P5AT)	2011 - 2018
	CX-7 (ER)	2.3L (MZR DISI / L3)	2006 - 2012
	CX-7 (ER)	2.5L (L5)	2009 - 2012
	Mazda 3 (BK - BL)	2.0L - 2.3L	2004 - 2014
	Mazda 3 (BL)	2.5L (L5)	2009 - 2014
	Mazda 6 (GG - GY)	2.3L (MZR/L3)	2002 - 2008
	Mazda 6 (GH)	2.5L (L5)	2008 - 2012
	MX5 (NC)	2.0L (MZR)	2005 - 2015
	Tribute (YU)	2.0L (YF)	2000 - 2004
	Tribute	2.3L (L3)	2004 - 2008

CONTENTS

Tool Ref.	Toledo Tool No.	OEM Tool No.	Description
A	A0001		Tensioner Locking Pin
B	A0011	303-1054	Chain Tensioner Locking Pin
C	A0049		Locking Pins
D	A0081		Injection Pump Locking Pin
E	A0083	21-263, 303-735, 999 7122	Camshaft Locking Pin
F	A0084	21-263, 303-735, 999 7122	Camshaft Locking Pin
G	A0089	21-262, 303-734, 999 7121	Crankshaft Locking Pin
H	A0092	21-263, 303-735, 999 7122	Camshaft Locking Pin
I	A0103		Locking Pin
J	A0107	07744-0010400, 21-260, 303-732, 999 7169, 999 7233	Camshaft Timing Pins
K	A0121	303-748	Flywheel Locking Tool Adaptors
L	A0122	21-210, 303-507, 49 JE01 061	Crankshaft Timing Pin
M	A0124	21-163, 303-620	Crankshaft Timing Pin
N	A0132		Locking Pin
O	A0147		
P	A0193	21-234, 21-251, 303-675, 303-698	Flywheel Locking Pin
Q	A0216	303-1059, 999 7121	Flywheel Timing Pin
R	A0257	303-1061, 49 UN30 310610	Camshaft Alignment Tool
S	A0361	303-1097	Camshaft Sprocket Locking Tool
T	A0406	303-393, 999 7119	Flywheel Locking Tool
U	A0418	21-162, 303-376, 49 JE01 054	Camshaft Setting Bar
V	A0435	303-393-01, 303-393-02, 999 7120	Flywheel Locking Tool Adaptors
W	A0608	49 B011 105	Crankshaft Pulley Holding Tool
X	A0618		Flywheel Locking Tool Adaptors

TOOL REFERENCE

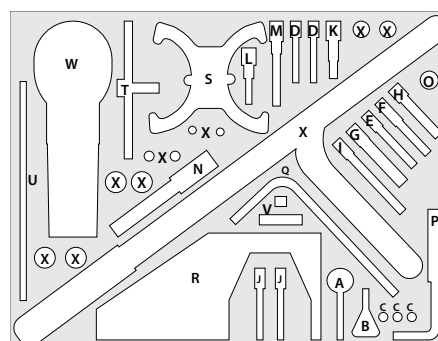

TIMING CHAIN KIT  Petrol

- Suitable for popular Falcon 6 cylinder applications
- For use during the removal and installation of the timing chain, cylinder head and other engine servicing and repairs



APPLICATION LIST*

Part No.	Make & Model	Engine	Year
304707	Ford		
	Fairlane (NA - AU)	3.9L, 4.0L	1988 - 2002
	Falcon (EA - AU)	3.2L, 3.9L, 4.0L	1988 - 2002
	LTD (DA - AU)	3.9L, 4.0L	1988 - 2002

CONTENTS

Tool Ref.	Toledo Tool No.	OEM Tool No.	Description
A	A0027	E9338, E9338A	Tensioner Locking Tools
B	A0615		Timing Chain Adjusting Tool

TOOL REFERENCE

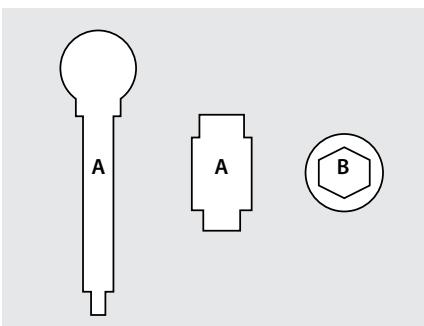

TIMING TOOL KIT  Diesel

- Suitable for popular 1.6L DOHC 16V TDCi diesel engine applications
- For the locking of the camshafts and crankshaft during the removal and installation of engine timing belt



APPLICATION LIST*

Part No.	Make & Model	Engine	Year
304729	Ford		
	Fiesta (WS)	1.6L (TDCi)	2009 - 2010
	Fiesta (WT)	1.6L (TDCi)	2010 - 2012
	Volvo		
	C30	1.6L (Diesel)	2009 - 2012

CONTENTS

Tool Ref.	Toledo Tool No.	OEM Tool No.	Description
A	A0193	21-234, 21-251, 303-675, 303-698	Flywheel Locking Pin
B	A0083	21-263, 303-735, 999 7122	Camshaft Locking Pin
C	A0089	21-262, 303-734, 999 7121	Crankshaft Locking Pin
D	A0108	07744-0010400, 21-2160, 303-732, 999 7169, 999 7233	Camshaft Timing Pin

TOOL REFERENCE

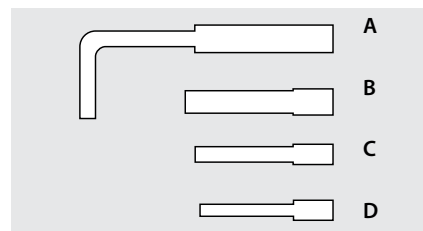

TIMING TOOL KIT

- Suitable for popular 1.8L – 2.5L DOHC 16V petrol engine applications
- For the locking of the camshaft and crankshaft during the removal and installation of the engine timing belt or chain

NOTE: Not suitable for Turbo engine applications



CAMSHAFT LOCKING KIT

- Suitable for popular Explorer 4.6L V8 SOHC 16V petrol engine applications
- For the locking and alignment of camshafts during engine servicing and repairs



APPLICATION LIST*

Part No.	Make & Model	Engine	Year
304730	Ford		
	Fiesta(WP - WQ)	1.6L - 2.0L	2004 - 2009
	Focus (LR - LV)	1.6 L - 2.0L	2000 - 2011
	Mondeo (MA - MC)	2.3L	2007 - 2015
	Mazda		
	CX-7 (ER)	2.5L (L5)	2009 - 2012
	Mazda 3 (BK - BL)	2.0L, 2.5L	2004 - 2014
	Mazda 6 (GG - GY)	2.0L, 2.3L, 2.5L	2002 - 2012
	Tribute (YU)	2.0L (YF)	2001 - 2004
	Tribute	2.3L (L3)	2004 - 2008

APPLICATION LIST*

Part No.	Make & Model	Engine	Year
304736	Ford		
	Explorer (UT)	4.6L (V8)	2001 - 2003
	Explorer (UX)	4.6L (V8)	2003 - 2003
	Explorer (UZ)	4.6L (V8)	2003 - 2008

CONTENTS

Tool Ref.	Toledo Tool No.	OEM Tool No.	Description
A	A0121	21-259, 303-748, 49 JE02 061	Crankshaft Locking Pin
B	A0122	21-210, 303-507, 49 JE01 061	Crankshaft Locking Pin
C	A0124	21-163, 303-620	Crankshaft Timing Pin
D	A0418	21-162, 303-376, 49 JE01 054	Camshaft Setting Bar

CONTENTS

Tool Ref.	Toledo Tool No.	OEM Tool No.	Description
A	A0518	303-380 (T91P-6256-A)	Camshaft Alignment Tool
B	A0519	303-413 (T92P-6256-A)	Camshaft Alignment Tool - Adaptor

TOOL REFERENCE

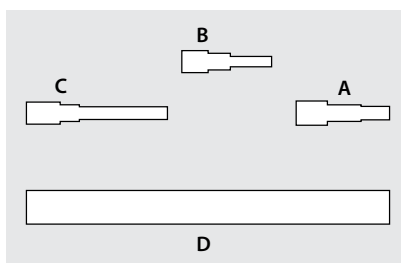

TOOL REFERENCE

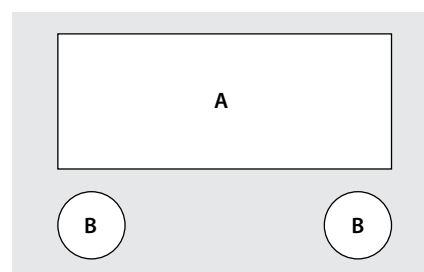

TIMING TOOL KIT 

- Suitable for popular 4, 5 and 6 cylinder DOHC petrol engine applications
- For the locking of camshafts during the removal and installation of the engine timing belt and other engine servicing and repairs

Note: Applications may require additional tools to complete repairs



APPLICATION LIST*

Part No.	Make & Model	Engine	Year
304737	Ford		
	Focus XR5 Turbo (LS - LV)	2.5L (B5254T)	2006 - 2012
	Kuga (TE)	2.5L (Duratec)	2012 - 2013
	Mondeo XR5 Turbo (MA - MB)	2.5L (B5254T)	2007 - 2014
	Volvo		
	850, 850(T)	2.3L, 2.4L (B52)	1992 - 1997
	960	2.9L (B630)	1991 - 1997
	C30, C30(T)	2.4L, 2.5L (B52)	2007 - 2013
	C70, C70(T)	2.3L - 2.5L (B52)	1999 - 2015
	S40, S40(T)	1.9L - 2.5L (B41, B42, B52)	1997 - 2013
	S60, S60(T)	2.0L - 2.5L (B52)	2000 - 2009
	S70, S70(T)	2.3L, 2.4L (B52)	1997 - 2003
	S80, S80(T)	2.0L - 2.9L (B52, B62, B63)	1998 - 2006
	V40, V40(T)	1.8L, 2.0L (B41, B42)	1997 - 2004
	V50, V50(T)	2.4L, 2.5L (B52)	2004 - 2015
	V70, V70(T)	2.0L - 2.5L (B52)	1997 - 2008
	XC70, XC70(T)	2.3L - 2.5L (B52)	2000 - 2007
	XC90, XC90(T)	2.5L - 2.9L (B52, B62)	2003 - 2006

BELT INSTALLATION KIT  

- Suitable for popular 1.9L – 2.5L DOHC petrol and 2.5L DOHC diesel engine applications
- For locking the crankshaft during engine repairs, servicing and timing belt replacement

Note: Applications may require additional tools to complete repairs



APPLICATION LIST*

Part No.	Make & Model	Engine	Year
304738	Ford		
	Focus XR5 Turbo (LS - LV)	2.5L (B5254T)	2006 - 2012
	Kuga (TE)	2.5L (Duratec)	2012 - 2013
	Mondeo XR5 Turbo (MA - MB)	2.5L (B5254T)	2007 - 2014
	Volvo		
	850	2.5L (B5252S)	1993 - 1996
	C30, S70, V70	2.0L - 2.5L (B52, D52)	1997 - 2015
	S40, V40	1.8L - 2.5L (B41, B42, B52)	1997 - 2018
	S60, S60	2.0L - 2.5L (B52, D52)	2000 - 2018
	V50	2.4L, 2.5L (B52, D52)	2004 - 2015
	S80, S80(T)	2.0L - 2.8L (B52, B62 D52)	1998 - 2010
	XC60, XC70, XC90	2.0L - 2.5L (B52, D52)	2000 - 2018

CONTENTS

Tool Ref.	Toledo Tool No.	OEM Tool No.	Description
A	A0645	999 7109	Auxiliary Drive Belt Tensioner Tool
B	A0646	999 5433	Crankshaft Pulley Holding Tool
C	A0647	303-1179	Auxiliary Drive Belt Installer

TOOL REFERENCE

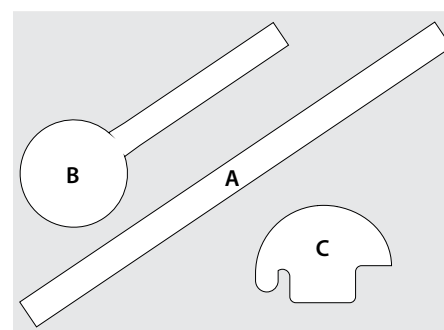

TIMING TOOL KIT

- Ford Falcon, Focus & Mondeo 2.0L DOHC 16V Ecoboost petrol engines
- For the locking and alignment of the camshafts, crankshaft and tensioner during the removal and installation of the engine timing chain and other engine servicing and repairs



APPLICATION LIST*

Part No.	Make & Model	Engine	Year
304753	Ford		
	Falcon (FG)	2.0L (Ecoboost)	2012 - 2016
	Focus (LW - LZ)	2.0L (Ecoboost)	2011 - 2018
	Mondeo (MC - MD)	2.0L (Ecoboost)	2011 - 2018

CONTENTS

Tool Ref.	Toledo Tool No.	OEM Tool No.	Description
A	A0121	303-748	Crankshaft Timing Pin
B	A0122	303-507	Crankshaft Timing Pin
C	A0717	303-1054	Tensioner Pin 3mm
D	A0718	303-1504	Camshaft Alignment Plate
E	A0719	303-1521	Crankshaft Alignment Pin
F	A0720	303-1565	Camshaft Alignment Tool

TOOL REFERENCE

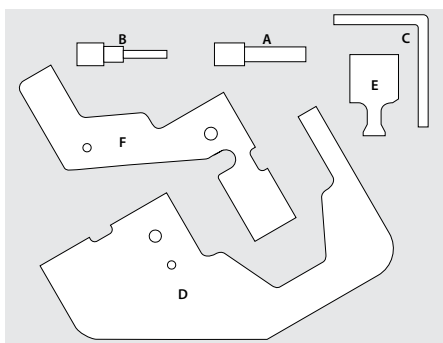

TIMING TOOL KIT

- Suitable for popular 1.5L – 2.5L DOHC 16V (including turbo) petrol engine applications.
- For the locking of the camshafts and crankshaft during the removal and installation of the engine timing belt or chain



APPLICATION LIST*

Part No.	Make & Model	Engine	Year
304754	Ford		
	Escape (ZB - ZD)	2.3L (L3)	2004 - 2012
	Fiesta (WP, WQ)	1.6L - 2.0L	2004 - 2008
	Focus (LR - LV)	1.6L - 2.0L	2000 - 2011
	Mondeo (MA - MC)	2.3L	2007 - 2015
	Ranger (PX)	2.5L (DPAT)	2011 - 2015
	Mazda		
	CX-3	2.0L	2015 - 2018
	CX-5, CX-7	2.0L - 2.5L	2006 - 2018
	Mazda2 (DE - DJ)	1.5L	2010 - 2017
	Mazda3 (BK - BM)	2.0L, 2.3L, 2.5L	2004 - 2017
	Mazda6 (GG - GJ)	2.0L, 2.3L, 2.5L	2002 - 2017
	Tribute	2.0L - 2.3L	2000 - 2008

CONTENTS

Tool Ref.	Toledo Tool No.	OEM Tool No.	Description
A	A0121	21-259, 303-748, 49 JE02 061	Crankshaft Locking Pin
B	A0122	21-210, 303-507, 49 JE01 061	Crankshaft Locking Pin
C	A0124	21-163, 303-620	Crankshaft Timing Pin
D	A0257	303-1061, 49 UN30 310610	Camshaft Alignment Tool
E	A0418	21-162, 303-376, 49 JE01 054	Camshaft Setting Bar

TOOL REFERENCE

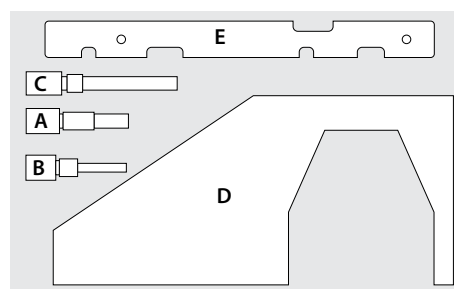

TIMING TOOL KIT

- Suitable for popular Ford and FPV, Falcon and Territory 4.0L (6 Cyl incl Turbo) and 5.4L V8 DOHC 32V (BOSS 260 - 315) petrol engine applications only
- For the locking of the camshafts and crankshaft during the removal and installation of the engine timing chain and other engine servicing and repairs

Note: Kit not suitable for Barra 5.4L V8 (24V) engine applications



APPLICATION LIST*

Part No.	Make & Model	Engine	Year
304755	Ford		
	Falcon (BA - FG)	4.0L (BARRA 182, 190, 195)	2002 - 2016
	Falcon (BA - FG) Turbo	4.0L (BARRA 240T, 270T)	2002 - 2016
	Falcon (BA - FG)	5.4L (BOSS 260, 290)	2003 - 2011
	Territory (SX - SZ)	4.0L (BARRA 182, 190, 195)	2004 - 2016
	Territory (SY) Turbo	4.0L (BARRA 245T)	2006 - 2010
	FPV		
	Falcon (BA - FG)	5.4L (BOSS 290, 302, 315)	2003 - 2010
	Falcon (BF) Turbo	4.0L (BARRA 240T, 270T)	2005 - 2008
	Territory (SY) Turbo	4.0L (BARRA 270T)	2008 - 2009

CONTENTS

Tool Ref.	Toledo Tool No.	OEM Tool No.	Description
A	A0649	303-446 (T93P-6256-AHR)	Camshaft Holding Tool (8 Cyl)
B	A0650	303-448 (T93P-6303-A)	Crankshaft Alignment Tool
C	A0651	303-445 (T93P-6256-A)	Camshaft Alignment Tool
D	A0652	303-447 (T93P-6256-BH)	Timing Belt Tensioner
E	A0676	303-777	Timing Chain Tensioner Release Tool
F	A0677	303-778	Camshaft Holding Tool (6 Cyl)

TOOL REFERENCE

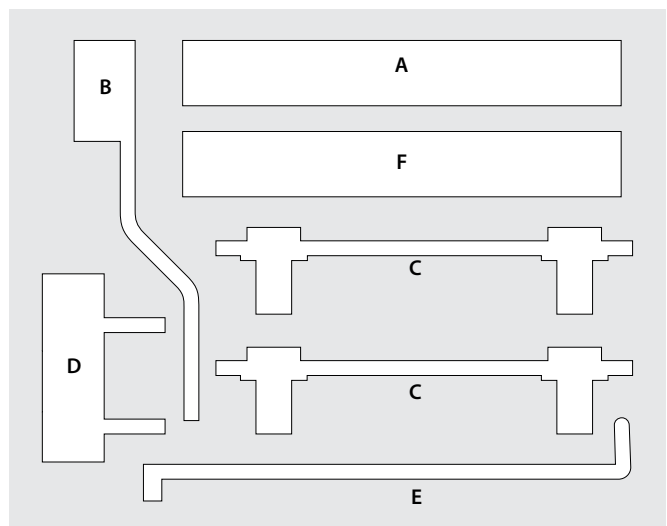

Also suitable: Part No. 304739

TIMING TOOL KIT



- Suitable for popular Falcon 5.4L V8 DOHC 32V (BOSS 260 and BOSS 290) petrol engine applications only



TIMING TOOLS

FORD

TIMING TOOL KIT

- Suitable for popular Ford Volvo 1.3L - 1.6L DOHC 16V petrol engine models
- For the locking and alignment of the camshafts, crankshaft and tensioner during the removal and installation of the engine timing chain and other engine servicing and repairs



TIMING TOOL KIT

- Suitable for popular Ford Ranger and Transit, Landrover Defender and Mazda BT50 2.2L and 2.4L (4cyl) and 3.2L (5cyl) turbo diesel engine applications
- For the locking of the camshafts and crankshaft during the removal and installation of the engine timing chain and other engine servicing and repairs



APPLICATION LIST*

Part No.	Make & Model	Engine	Year
304762	Ford		
	Ecosport (BK)	1.5L	2013 - 2017
	Fiesta (WS - WZ)	1.6L	2009 - 2014
	Fiesta (WZ)	1.5L	2013 - 2014
	Focus (LW)	1.6L	2011 - 2015
	KA	1.3L	2002 - 2008
	Kuga (TF)	1.6L	2013 - 2015
	Volvo		
	S60, V60 (T4)	1.6L (B4164T)	2011 - 2017

APPLICATION LIST*

Part No.	Make & Model	Engine	Year
304769	Ford		
	Ranger (PX)	2.2L (P4AT)	2011 - 2018
	Ranger (PX)	3.2L (P5AT)	2014 - 2018
	Transit (VH)	2.4L	2001 - 2006
	Transit (VM)	2.2L (Duratorq)	2006 - 2012
	Transit (VM)	2.4L	2006 - 2012
	Transit (VN)	2.2L (2.2DT)	2013 - 2018
	Land Rover		
	Defender (90, 110, 130)	2.2L (DT244)	2012 - 2018
	Defender (90, 110, 130)	2.4L (244DT)	2007 - 2012
	Mazda		
	BT50 (UP)	2.2L (P4AT)	2011 - 2015
	BT50 (UP)	3.2L (P5AT)	2011 - 2015
	BT50 (UR)	2.2L (P4AT)	2015 - 2018
	BT50 (UR)	3.2L (P5AT)	2015 - 2018

CONTENTS

Tool Ref.	Toledo Tool No.	OEM Tool No.	Description
A	A0121	303-748, 999 7406	Camshaft Alignment Pin
B	A0361	303-1097, 999 7429	Camshaft Sprocket Locking Tool
C	A0717	303-1054	Chain Tensioner Locking Pin
D	A0722	303-1550, 999 7431	Crankshaft Pulley Alignment Tool

TOOL REFERENCE

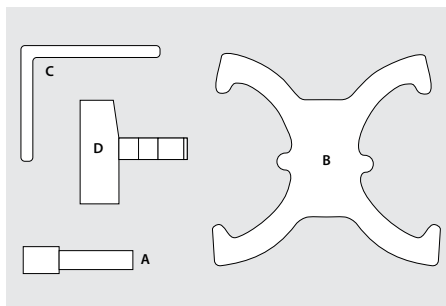

TIMING TOOL & SEAL INSTALLATION KIT

- Suitable for popular Ford Ranger and Transit, Landrover Defender and Mazda BT50 2.2L and 2.4L (4cyl) and 3.2L (5cyl) turbo diesel engine applications
- For the locking of the camshafts and crankshaft during the removal and installation of the engine timing chain, crankshaft oil seal replacement and other engine servicing and repairs



APPLICATION LIST*

Part No.	Make & Model	Engine	Year
304764	Ford		
	Ranger (PX)	2.2L (P4AT)	2011 - 2018
	Ranger (PX)	3.2L (P5AT)	2014 - 2018
	Transit (VH)	2.4L	2001 - 2006
	Transit (VM)	2.2L (Duratorq)	2006 - 2012
	Transit (VM)	2.4L	2006 - 2012
	Transit (VN)	2.2L (2.2DT)	2013 - 2018
	Land Rover		
	Defender (90, 110, 130)	2.2L (DT244)	2012 - 2018
	Defender (90, 110, 130)	2.4L (244DT)	2007 - 2012
	Mazda		
	BT50 (UP)	2.2L (P4AT)	2011 - 2015
	BT50 (UP)	3.2L (P5AT)	2011 - 2015
	BT50 (UR)	2.2L (P4AT)	2015 - 2018
BT50 (UR)	3.2L (P5AT)	2015 - 2018	

CONTENTS

Tool Ref.	Toledo Tool No.	OEM Tool No.	Description
A	A0192	303-675 303-698 22-251	Flywheel Locking Pin
B	A0383	303-1151	Fuel Injection Pump Locking Tool
C	A0384	303-679A	Crankshaft Oil Seal Removal/Installation Tool
D	A0753	303-1587	Crankshaft Sprocket Locking Tool
E	A0754	6mm x 2	2 x Camshaft Timing Pins (6mm)
F	A0755	303-682	Timing Cover Aligning Tool

TOOL REFERENCE

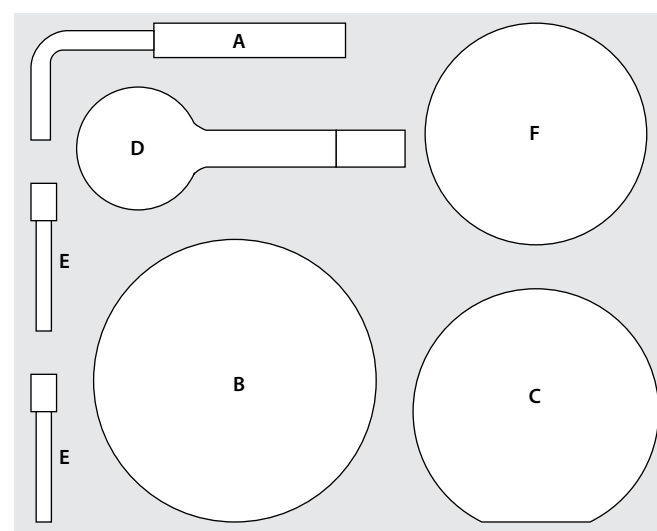

TIMING TOOL KIT Diesel

- Suitable for popular Ford Territory 2.7L TDI diesel engine applications
- For locking and alignment of the camshafts, crankshaft and tensioner during removal and installation of the engine timing belt and other engine servicing and repairs



APPLICATION LIST*

Part No.	Make & Model	Engine	Year
304786	Ford		
	Territory (SZ)	2.7L (276DT)	2011 - 2016

CONTENTS

Tool Ref.	Toledo Tool No.	OEM Tool No.	Description
A	A0100	303-1132	Camshaft Sprocket Aligning Tool
B	A0101	303-1126	Camshaft Sprocket Alignment Pin
C	A0756	303-1585	Flywheel Locking Tool
D	A0757	303-1586	Flywheel Locking Tool

TOOL REFERENCE

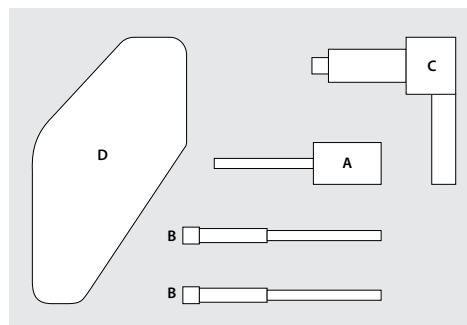

Also suitable: Part No. 304739

TIMING TOOL KIT



- Suitable for popular FPV 5.4L V8 DOHC 32V (BOSS 260 - 315) engines



Also suitable: Part No. 304755

TIMING TOOL KIT



- Suitable for popular Ford and FPV, Falcon and Territory 4.0L (6 Cyl incl Turbo) and 5.4L V8 DOHC 32V (BOSS 260 - 315)
- For full kit contents refer to page 149



TIMING TOOL KIT 

- Suitable for 1.8L Z18XER & F18D DOHC 16V petrol applications
- For the locking and alignment of the camshafts, crankshaft and tensioner during the removal and installation of the engine timing belt and other engine servicing and repairs



APPLICATION LIST*

Part No.	Make & Model	Engine	Year
304710	Holden		
	Astra (AH)	1.8L (Z18XER)	2007 - 2010
	Barina (TM)	1.6L (F16D4)	2011 - 2018
	Cruze (JG - JH)	1.8L (F18D4)	2009 - 2018
	Cruze (JH)	1.6L (A16LET)	2013 - 2018
	Opel		
	Astra (1.6i)	1.6L (A16LET)	2012 - 2013
Corsa (OPC)	1.6L (A16LET)	2013 - 2013	

CONTENTS

Tool Ref.	Toledo Tool No.	OEM Tool No.	Description
A	A0113	KM-6349	Auxiliary Drive Belt Tensioner Locking Tool
B	A0217	KM-6333	Cam Belt Tension Lock Pin
C	A0379	KM-6340	Camshaft Lock Tool
D	A0610	KM-6625	Flywheel Locking Tool
E	304710A	KM-6628(A)	Camshaft Setting Bar

TOOL REFERENCE

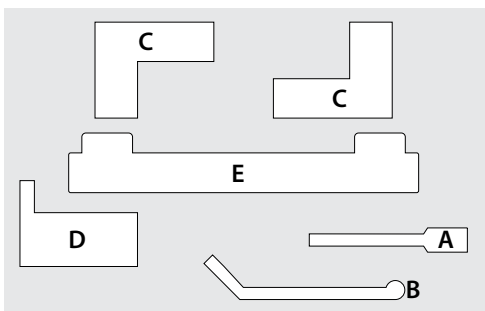

Also suitable: Part No. 304710A CAMSHAFT SETTING BAR



- Suitable for Holden Astra (AH) 1.8L Z18XER DOHC 16V petrol application
- Used in addition with 304710, 304710A to reset camshafts only



TIMING TOOL KIT 

- Suitable for popular 2.2L (Z22SE / Z22YH) DOHC 16V petrol engine applications
- For the locking and alignment of the camshaft, crankshaft, tensioner and water pump during the removal and installation of the engine timing chain and other engine servicing and repairs



APPLICATION LIST*

Part No.	Make & Model	Engine	Year
304711	Holden		
	Astra (TS)	2.2L (Z22SE)	2001 - 2007
	Astra (AH)	2.2L (Z22YH)	2006 - 2010
	Vectra (ZC)	2.2L (Z22SE)	2003 - 2006
	Zafira (TT)	2.2L (Z22SE)	2001 - 2006

CONTENTS

Tool Ref.	Toledo Tool No.	OEM Tool No.	Description
A	A0001	KM-6077	Tensioner Locking Pin
B	A0064		Bolts
C	A0385	KM-J-43651	Water Pump Holding Tool
D	A0397	KM-6148	Camshaft Locking Tool
E	A0613	KM-956-1, KM-J-38122-A	Crankshaft Pulley Holder

TOOL REFERENCE

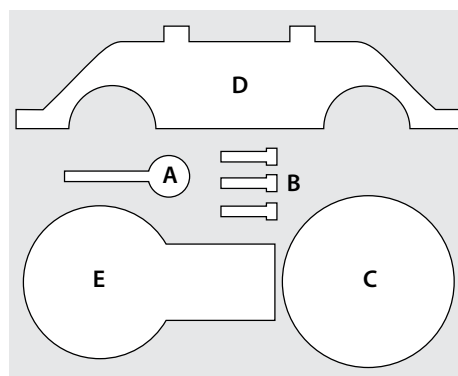

TIMING TOOL KIT

- Suitable for popular 1.2L – 2.2L petrol and 1.9L diesel engine applications
- For the locking and alignment of the camshafts, crankshaft, tensioner and water pump during the removal and installation of the engine timing belt, chain and other engine servicing and repairs



APPLICATION LIST*

Part No.	Make & Model	Engine	Year
304712	Alfa Romeo		
	147, 159	1.9L (Diesel)	2006 - 2012
	159 (JTD)	2.4L (Diesel)	2006 - 2012
	Giulietta	2.0L (Diesel)	2012 - 2015
	Fiat		
	Bravo, Ritma	1.9L (Diesel)	2007 - 2009
	Doblo, Freemont	2.0L (Diesel)	2013 - 2018
	Holden		
	Astra (TS - AH)	1.8L (X18, Z18)	1998 - 2010
	Astra (TS - AH) Turbo	2.0L (Z20LER,T)	2003 - 2010
	Astra (TS - AH)	2.2L (Z22)	2001 - 2010
	Astra (AH) Diesel	1.9L (Z19DT)	2006 - 2010
	Barina, Combo (SB)	1.2L, 1.4L (C12, C14)	1994 - 2002
	Barina, Combo (XC)	1.4L - 1.8L (Z14, Z16, Z18)	2001 - 2013
	Barina (TM)	1.6L (F16D4)	2011 - 2018
	Cruze (JG - JH)	1.8L (F18D4)	2009 - 2018
	Cruze (JH)	1.6L (A16LET)	2013 - 2018
	Tigra (XC)	1.8L (Z18XE)	2005 - 2007
	Vectra (JR - JS)	2.0L, 2.2L (C20, C22SEL)	1998 - 2006
	Zafira (TT)	2.2L (Z22SE)	2001 - 2006
	HSV		
	VXR (AH)	2.0L (Z20LEH)	2006 - 2009
	Opel		
	Astra (1.6i)	1.6L (A16LET)	2012 - 2013
	Corsa (OPC)	1.6L (A16LET)	2013 - 2013
	Zafira (TGF75)	1.8L (X18XE)	2001 - 2004
	Saab		
	9-3 (1.9 TiD)	1.9L (Z19DTR)	2007 - 2012
	9-5 (1.9 TiD)	1.9L (Z19DTH)	2008 - 2009
	9-5 (2.0 TiD)	2.0L (A20DTH)	2011 - 2012

CONTENTS

Tool Ref.	Toledo Tool No.	OEM Tool No.	Description
A	A0001	KM-6077	Tensioner Locking Pin
B	A0038	KM-952	Crankshaft Locking Pin
C	A0064		Bolts
D	A0067		Bolt
E	A0106	KM-955-1	Timing Chain Tensioner Locking Pin
F	A0113	KM-6130, KM-6349	Auxiliary Drive Belt Tensioner Locking Tool
G	A0175	EN-46788	Crankshaft Locking Tool And Bolt
H	A0184	1.870.986.900, EN-46789	Camshaft Locking Tools
I	A0196	KM-911	Flywheel Locking Tool
J	A0217	KM-6333	Cam Belt Tension Lock Pin
K	A0283	KM-954	Camshaft Position (CMP) Sensor Disc Setting Tool
L	A0333	1.860.905.000, 1.860.905.010	Crankshaft Alignment Tool
M	A0370	KM-853	Camshaft Locking Tool
N	A0371	KM-852	Camshaft Locking Tool
O	A0379	KM-6340	Camshaft Locking Tool
P	A0385	KM-J-43651	Water Pump Holding Tool
Q	A0397	KM-6148	Camshaft Locking Tool
R	A0418	21-162, 303-376, 49 JE01 054	Camshaft Setting Bar
S	A0610	KM-6625	Flywheel Locking Tool
T	A0613	KM-956-1, KM-J-38122-A	Crankshaft Pulley Holder
U	A0616	KM-421-A, KM-6283	Water Pump Wrench (41mm)
V	A0617	KM-421-B, KM-6283	Water Pump Wrench (46mm)
W	304710A	KM-6628(A)	Camshaft Setting Bar

TOOL REFERENCE

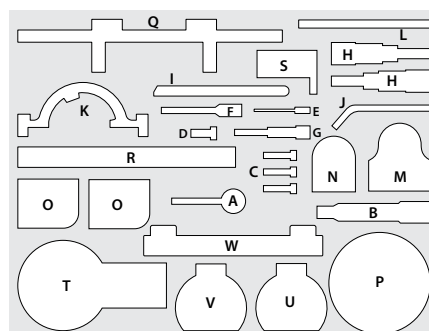

TIMING TOOL KIT 

- Suitable for popular 2.5L – 3.2L DOHC 24V petrol engine applications
- For the locking and alignment of the camshafts and crankshaft during the removal and installation of the engine timing belt and other engine servicing and repairs



APPLICATION LIST*

Part No.	Make & Model	Engine	Year
304713	Holden		
	Calibra	2.5L (C25XE)	1995 - 1998
	Vectra (JR - JS)	2.5L (X25XE)	1997 - 2000
	Vectra (JS)	2.6L (Y26SE)	2000 - 2001
	Vectra (ZC)	3.2L (Z32SE)	2003 - 2006

CONTENTS

Tool Ref.	Toledo Tool No.	OEM Tool No.	Description
A	A0308	KM-800-10	Crankshaft Locking Tool
B	A0359	KM-800-20	Camshaft Timing Gauge
C	A0366	KM-800-1	Camshaft Lock Tool (RED)
D	A0367	KM-800-2	Camshaft Lock Tool (GREEN)
E	A0434	KM-800-30	Belt Holding Tool

TOOL REFERENCE

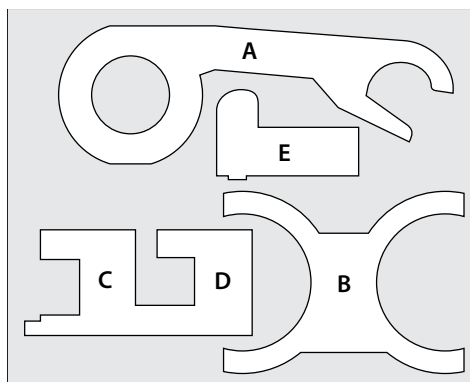

Also suitable: Part No. 304712A
WATER PUMP WRENCH



- 41mm
- Suitable for Barina TK 1.6L applications



TIMING TOOL KIT 

- Suitable for 2.0L (Z20S1) SOHC 16V turbo diesel models
- For the locking of the camshaft and crankshaft during the removal and installation of the engine timing belt



APPLICATION LIST*

Part No.	Make & Model	Engine	Year
304723	Holden		
	Captiva (CG)	2.0L (Z20S1)	2007 - 2011
	Cruze (JG)	2.0L (Z20S1)	2009 - 2011
	Epica (EP)	2.0L (Z20S1)	2008 - 2011

CONTENTS

Tool Ref.	Toledo Tool No.	OEM Tool No.	Description
A	A0089	EN-48246	Crankshaft Locking Pin
B	A0633	EN-48245	Camshaft Locking Tool
C			Bolts

TOOL REFERENCE

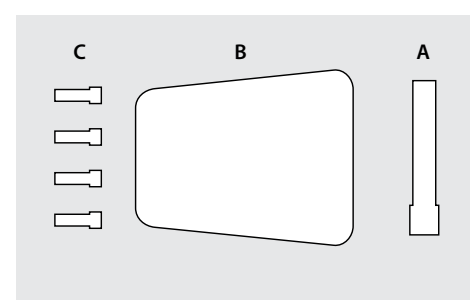

Also suitable: Part No. 304712B
WATER PUMP WRENCH



- 46 mm
- Suitable for popular Holden 4 cylinder applications



TIMING TOOL KIT

- Suitable for 3.6L (V6) DOHC 24V petrol engine applications
- For the locking of the camshafts during engine servicing and repairs

NOTE: Not suitable for SIDI engine applications



APPLICATION LIST*

Part No.	Make & Model	Engine	Year
304732	Holden		
	Captiva (CG)	3.2L (LU1)	2006 - 2011
	Commodore (VZ)	3.6L (LE0, LY7)	2004 - 2006
	Commodore (VE)	3.6L (LE0, LY7)	2006 - 2009
	Rodeo (RA)	3.6L	2005 - 2008
	Statesman (WL)	3.6L (LY7)	2004 - 2006
	Statesman (WM)	3.6L (LY7)	2006 - 2009

CONTENTS

Tool Ref.	Toledo Tool No.	OEM Tool No.	Description
A	A0624	EN-46105-1	Camshaft Alignment Tool 1 (RH Cam)
B	A0625	EN-46105-2	Camshaft Alignment Tool 2 (LH Cam)

TOOL REFERENCE

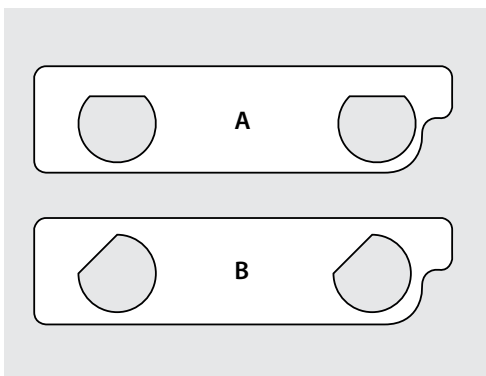

TIMING TOOL KIT

- Suitable for popular 1.4L, 1.8L, 2.0L and 2.2L DOHC 16V petrol applications
- For the locking and alignment of the camshafts, crankshaft and tensioner during the removal and installation of the engine timing belt and other engine servicing and repairs



APPLICATION LIST*

Part No.	Make & Model	Engine	Year
304742	Holden		
	Astra (TS)	1.8L (X18XE)	1998 - 2000
	Astra (TS)	1.8L (Z18XE)	2001 - 2004
	Astra (TS Ser. II)	2.0L (Z20LET)	2003 - 2004
	Astra (AH)	1.8L (Z18XE)	2004 - 2007
	Astra (AH)	2.0L (Z20LER)	2006 - 2010
	Barina (XC)	1.4L (Z14XE)	2001 - 2004
	Barina (XC)	1.8L (Z18XE)	2001 - 2005
	Tigra (XC)	1.8L (Z18XE)	2005 - 2007
	Vectra (JR, JS)	2.0L (C20SEL)	1997 - 2000
	Vectra (JS)	2.2L (C22SEL)	1998 - 2002

CONTENTS

Tool Ref.	Toledo Tool No.	OEM Tool No.	Description
A	A0113	KM-6130	Auxiliary Drive Belt Tensioner Locking Tool
B	A0196	KM-911	Flywheel Locking Tool
C	A0370	KM-853	Camshaft Locking Tool
D	A0371	KM-852	Camshaft Locking Tool

TOOL REFERENCE

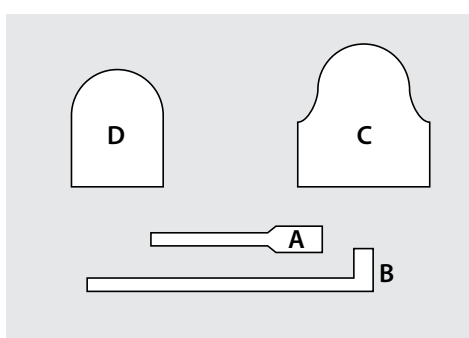

TIMING TOOL KIT 

- Suitable for 2.8L, 3.0L and 3.6L (V6) DOHC 24V SIDI petrol engine applications only
- For the locking of the camshafts during engine servicing and repairs



APPLICATION LIST*

Part No.	Make & Model	Engine	Year
304743	Holden		
	Captiva (CG)	3.0L (LF1/LFW)	2011 - 2018
	Colorado (RC)	3.6L (H9)	2008 - 2012
	Commodore (VE - VF)	3.0L (SIDI LF)	2009 - 2017
	Commodore (VE - VF)	3.6L	2009 - 2017
	Insignia (GA)	2.8L (A28NER)	2015 - 2018
	Opel		
	Insignia (OPC)	2.8L (A28NER)	2013 - 2013
	SAAB		
	9-3 (Aero)	2.8L (B284)	2006 - 2010

CONTENTS

Tool Ref.	Toledo Tool No.	OEM Tool No.	Description
A	A0654	EN-48383-1	Camshaft Alignment Tool 1 (LH Cam, Stage 1)
B	A0655	EN-48383-2	Camshaft Alignment Tool 2 (LH Cam, Stage 2)
C	A0656	EN-48383-3	Camshaft Alignment Tool 3 (RH Cam, Stage 2)

TOOL REFERENCE

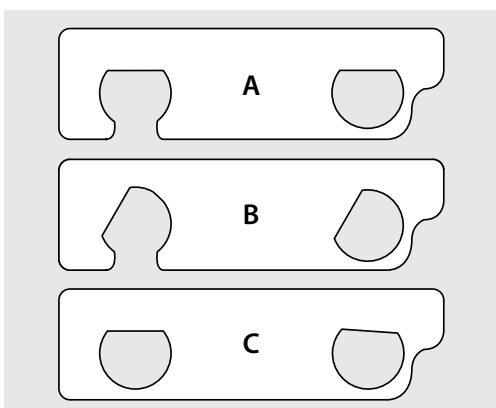

TIMING TOOL KIT 

- Suitable for popular Holden and Jeep 2.8L CRD Turbo Diesel engine applications
- Contains camshaft locking tools used in both early LWH (132kW) and later LWN (147kW) Colorado applications
- For the locking and alignment of the camshafts and crankshaft during the removal and installation of the engine timing belt and other engine servicing and repairs



APPLICATION LIST*

Part No.	Make & Model	Engine	Year
304749	Chrysler		
	Grand Voyager (RT)	2.8L (R428)	2008 - 2018
	Dodge		
	Nitro (KA)	2.8L (ENO)	2007 - 2010
	Holden		
	Colorado (RG)	2.4L (LVN)	2012 - 2018
	Colorado (RG - 132kW)	2.8L (LWH)	2012 - 2013
	Colorado (RG - 147kW)	2.8L (LWN)	2013 - 2018
	Jeep		
	Cherokee (KK)	2.8L (ENO/ENS)	2008 - 2013
	Wrangler (JK)	2.8L (ENS)	2007 - 2018

CONTENTS

Tool Ref.	Toledo Tool No.	OEM Tool No.	Description
A	A0658	EN-50029, VM.9991	Exhaust Camshaft Locking Tool
B	A0659	EN-50030, VM.9992	Crankshaft Locking Tool
C	A0661	EN-51025	Exhaust Camshaft Locking Tool
D	A0690	EN-51104	Fuel Pump Sprocket Locking Tool
E			Bolts

TOOL REFERENCE

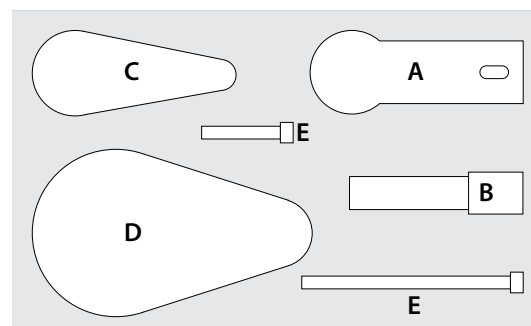

TIMING TOOL KIT

- Suitable for popular GM 1.4L DOHC 16V (A14) petrol engine models
- For the locking and alignment of the camshafts, crankshaft and tensioner during the removal and installation of the engine timing chain and other engine servicing and repairs



APPLICATION LIST*

Part No.	Make & Model	Engine	Year
304752	Holden		
	Barina (TM)	1.4L (A14NET)	2013 - 2014
	Cruze (JH)	1.4L (A14NET)	2011 - 2015
	Trax (TJ)	1.4L (A14NET)	2014 - 2018
	Volt (EV)	1.4L (LUU)	2012 - 2018
	Opel		
	Astra	1.4L (A14NET)	2012 - 2013
Corsa	1.4L (A14XER)	2012 - 2013	

CONTENTS

Tool Ref.	Toledo Tool No.	OEM Tool No.	Description
A	A0038	EN-952, KM-952	Crankshaft Locking Pin
B	A0106	EN-955-10, KM-955-2	Timing Chain Tensioner Locking Pin 4.0mm
C	A0108	KM-955-1	Timing Chain Tensioner Locking Pin 2.5mm
D	A0681	EN-49977-100	Camshaft Sensor Disc Setting Tool
E	A0682	EN-49977-200	Inlet Camshaft Adjuster Tool
F	A0715	EN-953-A, KM-953-A	Camshaft Lock Tool

TOOL REFERENCE

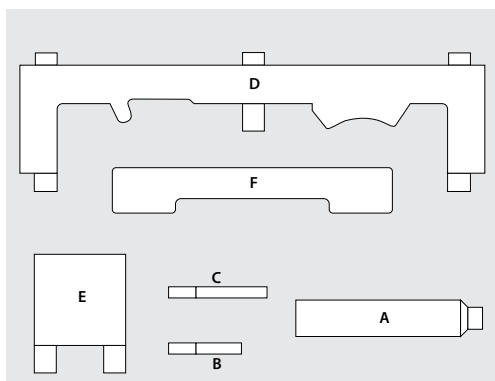

TIMING TOOL KIT

- Suitable for popular GM 2.0L (20NFT) and 2.4L (LE5/LE9) DOHC 16V turbo petrol engine models
- For the locking and alignment of the camshafts, crankshaft and tensioner during the removal and installation of the engine timing chain and other engine servicing and repairs



APPLICATION LIST*

Part No.	Make & Model	Engine	Year
304760	Holden		
	Astra (PJ)	2.0L (A20NFT)	2015 - 2018
	Captiva (CG)	2.4L (LE5/LE9)	2011 - 2018
	Malibu (EM)	2.4L (LE9)	2013 - 2017
	OPEL		
	Astra (OPC)	2.0L (A20NFT)	2012 - 2013
	Insignia (2.0i)	2.0L (A20NFT)	2012 - 2013
	SAAB		
	9-5 (2.0T)	2.0L (A20NFT)	2011 - 2012

CONTENTS

Tool Ref.	Toledo Tool No.	OEM Tool No.	Description
A	A0106	EN-955-20	Timing Chain Tensioner Locking Pin 4.0mm
B	A0108	EN-955-10	Timing Chain Tensioner Locking Pin 2.5mm
C	A0623	EN-45027	Tensioner Plunger Resetting Tool
D	A0706	EN-48953	Camshaft Adjuster Holding Tool
E	A0707	EN-43653	Flywheel/Drive Plate Holding Tool
F	A0728	EN-49212-1/2	Camshaft Adjuster Alignment Tool
F	A0729	EN-49212-1/2	Camshaft Adjuster Alignment Tool
G	A0730	EN-48585	Crankshaft Pulley Alignment Tool

TOOL REFERENCE

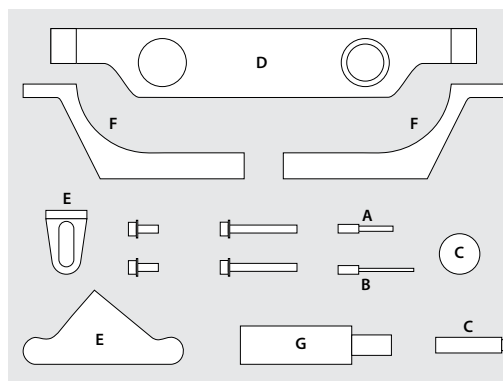

TIMING TOOL KIT



- Universal timing tool kit contains a comprehensive range of pulley holding and pulling tools suitable for popular Australian, Japanese and Korean applications
- For the locking and alignment of the camshafts, crankshaft, tensioner during the removal and installation of the engine timing belt, chain and other engine servicing and repairs



TOOL REFERENCE

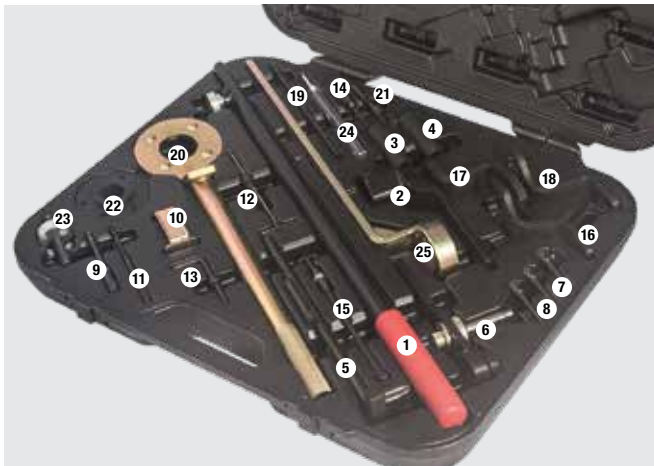

Part No.	Description
304734	Timing tool kit

CONTENTS

Tool Ref.	Toledo Tool No.	OEM Tool No.	Description
1	07-JAB-001020B	Honda	Handle Holder Crank Pulley
2	07-MAB-PY-30100	Honda	Holder Attachment Crank Pulley
3	JAA0010100V17	Honda	17mm Socket
4	JAA0010100V19	Honda	19mm Socket
5	18G1521	Honda	Camshaft Holder Tool
6	JAB-0010100	Honda	Tool Holder
7	18G1523	Honda	Flywheel Fixed Pin
8	18G1717A	Honda	Injection Pump Pin
9	07 LAG-PT 20100	Honda	Balance Shaft Fixed Pin
10	14540-P13-003	Honda	Clamp
11	07744-0010400	Honda	Driver Pin (5.0mm)
12	18G1719	Honda	Fixed Bolt
13	09244-28100	Hyundai / Mitsubishi	Locking Pin 3 x 112mm
14	09244-28100	Hyundai / Mitsubishi	Connecting Pin 14 x 55mm
15	09244-28000	Hyundai	Belt Spanner
16	KM 42 A	Daewoo / Holden	Water Pump Wrench (SW41)
17	MKM 472	Daewoo / Holden	Water Pump Wrench (SW46)
18	J 42492	Daewoo / Holden	Water Pump Wrench (SW40)
19	49 JE 01064	Mazda	Camshaft Holder Tool
20	499977000	Subaru	Crankshaft Pulley Holder
21	49 JE 01061	Mazda	OT Fixed Pin
22	49 JE 01002	Mazda	Pulley Holder
23	49 JE 01062	Mazda	Crankshaft Pulley Tool
24	49 JE 01050	Mazda	Crankshaft Pin
25	49 DO 11102	Mazda	Crankshaft Holder Tool

CAMSHAFT BELT TENSIONER LOCKING TOOLS

- Suitable for popular 1.6L – 3.8L petrol engine applications
- For the locking and alignment of the automatic tensioner during removal and installation of the engine timing belt



APPLICATION LIST*

Part No.	Make & Model	Engine	Year
304748	Hyundai		
	Lantra (J1 - J3)	1.6L - 1.8L (G4)	1991 - 2000
	Kia		
	Sorento (BL)	3.5L (G6CU)	2003 - 2009
	Mitsubishi		
	380 (DB)	3.8L (6G75)	2005 - 2008
	Express / Starwagon	2.0L - 3.0L	1994 - 2006
	Lancer (CG - CJ)	2.0L	2002 - 2015
	Magna (TS - TW)	3.0L - 3.5L	1994 - 2005
	Outlander (ZE - ZH)	2.4L	2003 - 2012
	Pajero (NL - NP)	3.5L - 3.8L	1997 - 2006
	Triton (MK - ML)	2.4L - 3.5L	1996 - 2011

FUEL PUMP SPROCKET REMOVING TOOL

- Suitable for popular Hyundai and Kia 1.4L, 1.5L, 1.6L and 1.7L common rail diesel (CRD) engine applications
- For locking the high pressure fuel pump and removal of the pump sprocket required for removal and installation of the engine timing chain and other engine servicing and repairs
- Contains high pressure fuel pump sprocket holder and puller, mounting plate and forcing screw
- OEM reference No. 09331-2A000



APPLICATION LIST*

Part No.	Make & Model	Engine	Year
304782	Hyundai		
	Accent (RB)	1.6L (D4FB)	2012 - 2013
	Getz (TB)	1.5L (D4FA)	2006 - 2011
	i30 (FD, GD)	1.6L (D4FB)	2007 - 2017
	i40 (VF)	1.7L (D4FD)	2011 - 2017
	Kia		
	Cerato (AF, EF)	1.6L (D4FB)	2006 - 2009
	Rio (JB)	1.5L (D4FA)	2010 - 2011
	Rio (UB)	1.4L (D4FC)	2012 - 2017
	Rondo (RP)	1.7L (D4FD)	2013 - 2017
	Soul (AJ)	1.6L (D4FB)	2009 - 2014

CONTENTS

Tool Ref.	Toledo Tool No.	OEM Tool No.	Description
A	A0555	MD998752, MB998767, 09241-28100	Tensioner Pulley Holding Tool
B	A0001		Tensioner Locking Pin
C	A0470		Locking Pin
D	A0556	MD998738, 09244-28000	Automatic Tensioner Tool Holding Screw

TOOL REFERENCE

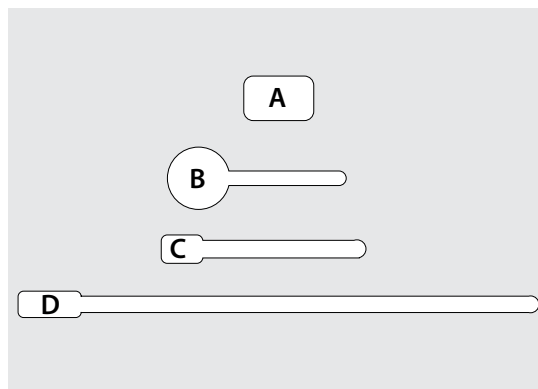

Also suitable: Part No. 304709

TIMING TOOL KIT



- Suitable for popular Jeep Grand Cherokee 2.7L diesel engine applications
- For full kit contents refer to page 164



Also suitable: Part No. 304749

TIMING TOOL KIT



- Suitable for popular Jeep Cherokee & Wrangler 2.8L diesel engine applications
- For full kit contents refer to page 157



CAMSHAFT LOCKING TOOL

- Suitable for Land Rover 2.5L TD5 Diesel models
- For the locking of the camshafts and flywheel/drive plate during engine servicing and repairs



APPLICATION LIST*

Part No.	Make & Model	Engine	Year
304744	Land Rover		
	Defender (90, 110, 130)	2.5L (10P, 15P)	2011 - 2018
	Discovery II (TD5)	2.5L (10P, 16P)	1999 - 2005

CONTENTS

Tool Ref.	Toledo Tool No.	OEM Tool No.	Description
A	A0533	LRT-12-058	Camshaft Timing Pin
B	A0534	LRT-12-158	Flywheel/Drive Plate Locking Tool

TIMING TOOL KIT

- Suitable for popular 2.7L & 3.0L TDI diesel engine applications
- For locking and alignment of the camshafts, crankshaft and tensioner during removal and installation of the engine timing belt and other engine servicing and repairs



APPLICATION LIST*

Part No.	Make & Model	Engine	Year
304746	Jaguar		
	S Type (2.7 D)	2.7L (AJD27)	2006 - 2008
	XF (Luxury)	2.7L (AJD27)	2008 - 2009
	XF (X250)	3.0L (AJV6D)	2009 - 2018
	XJ6 (X350)	2.7L (ELD11)	2007 - 2010
	XJ (X351)	3.0L (306DT)	2010 - 2018
	Land Rover		
	Discovery III, IV	2.7L (276DT)	2005 - 2012
	Discovery IV	3.0L (306DT)	2009 - 2014
	Range Rover		
	Range Rover (LG, LW)	3.0L (306DT)	2013 - 2018
	Sport	2.7L (ELD11)	2005 - 2009
	Sport	3.0L (306DT)	2009 - 2013

FUEL PUMP LOCKING TOOL

- High pressure fuel pump locking tool
- Suitable for popular 2.7L – 3.0L DOHC V6 diesel engine applications including XF, XJ, Discovery, Range Rover Sport*
- Allows the high pressure fuel pump to be locked in the timed position during belt removal and installation and other engine servicing and repairs
- OEM reference No. 310-212



APPLICATION LIST*

Part No.	Make & Model	Engine	Year
304784	Jaguar		
	XF (Luxury)	3.0L (AJV6D)	2008 - 2011
	XF (X250)	3.0L (AJV6D)	2009 - 2011
	XJ (X351)	3.0L (306DT)	2010 - 2016
	Land Rover		
	Discovery III (2.7 TDV6)	2.7L (276DT)	2005 - 2009
	Discovery IIII (2.7 TDV6)	2.7L (276DT)	2009 - 2012
	Discovery IIII (SDV6,TDV6)	3.0L (306DT)	2009 - 2014
	Range Rover		
	Range Rover (LG - LW)	3.0L (306DT)	2013 - 2018
	Sport	2.7L (ELD11)	2005 - 2009
	Sport	3.0L (306DT)	2009 - 2013

CONTENTS

Tool Ref.	Toledo Tool No.	OEM Tool No.	Description
A	A0100	303-1132	Camshaft Sprocket Aligning Tool
B	A0101	303-1126	Camshaft Sprocket Timing Pins
C	A0288	303-1116, 303-1117	Flywheel Locking Tool

TOOL REFERENCE

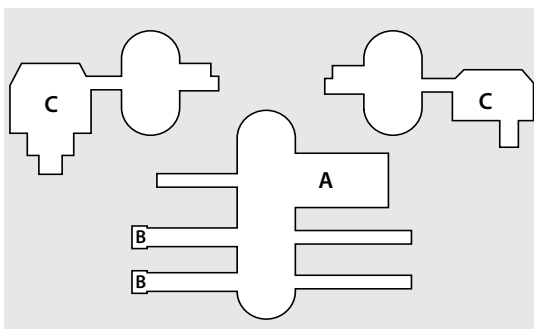

Also suitable: Part No. 304706

TIMING TOOL KIT



- Suitable for popular Mazda CX-7, Mazda 3, Mazda 6 and Tribute petrol engine applications
- **For full kit contents refer to page 143**



Also suitable: Part No. 304708

TIMING TOOL KIT



- Suitable for popular Mazda CX-7, Mazda 3, Mazda 6 and Tribute petrol engine applications
- **For full kit contents refer to page 144**



Also suitable: Part No. 304730

TIMING TOOL KIT



- Suitable for popular 1.8L – 2.5L DOHC 16V petrol engine applications
- For the locking of the camshaft and crankshaft during the removal and installation of the engine timing belt or chain
- Not suitable for Turbo models
- **For full kit contents refer to page 146**



Also suitable: Part No. 304754

TIMING TOOL KIT



- Suitable for popular Mazda CX-3, CX-5, Mazda 2, Mazda 3, Mazda 6 and Tribute petrol engine applications
- **For full kit contents refer to page 148**



Also suitable: Part No. 304764

TIMING TOOL KIT



- Suitable for popular Mazda BT50 diesel engine applications
- **For full kit contents refer to page 151**



TIMING TOOL KIT



- Suitable for popular 1.4L – 6.0L (4, 6, V6, V8 & V12) petrol and 2.1L – 3.2L (4, 5, 6 & V6) diesel engine applications
- For the locking and alignment of the camshafts, crankshaft and tensioner during the removal and installation of the engine timing chain and other engine servicing and repairs



APPLICATION LIST*

Part No.	Make & Model	Engine	Year
304709	Mercedes		
	A Class (A140 - A200)	1.4L - 2.0L	1998 - 2010
	B Series (B180 - B200)	1.7L - 2.0L	2005 - 2012
	C Class (C, CL, CLC, CLK, CLS)	1.8L - 6.0L	1994 - 2018
	E Class (E200 - E500)	1.8L - 5.5L	1993 - 2018
	G-Class (G, GL)	3.0L, 5.5L	2006 - 2018
	ML Class (ML270 - ML500)	2.7L - 5.5L	2000 - 2015
	R Class (R280 - R500)	3.5L - 5.5L	2006 - 2012
	S Class (S, SL, SLK)	1.8L - 6.0L	1993 - 2018
	Sprinter	2.1L - 3.0L	2000 - 2018
	Viano	2.1L - 3.0L	2005 - 2018
	Vito	2.1L - 3.0L	1998 - 2015
	Ssangyong		
	Actyon	2.0L, 2.3L	2007 - 2013
	Kyron	2.0L - 2.7L	2006 - 2012
	Rexton	2.7L (OM665)	2004 - 2013
	Stavic	2.7L (OM665)	2005 - 2008

CONTENTS

Tool Ref.	Toledo Tool No.	OEM Tool No.	Description
A	A0104	271589001500	Chain Tensioner Drift
B	A0231	111589031500	Camshaft Locking Pin
C	A0248	112589000100	Camshaft Spanner
D	A0249	112589013200	LH Camshaft Locking Tool
E	A0250	112589003200	RH Camshaft Locking Tool
F	A0259	601589024000	Flywheel Locking Tool
G	A0260	602589004000	Flywheel Plate Locking Tool
H	A0270	271589014000	Timing Chain to Camshaft Sprocket Holder
I	A0271	271589003100	Tensioner Rail Wedge
J	A0282	271589006100	Camshaft Holding Tool
K	A0341	271589004000	Crankshaft Holding Tool
L	A0619		Balancer Shaft Chain Link Installer Die Kit
M	A0648	112589034000	Flywheel Locking Tool

TOOL REFERENCE

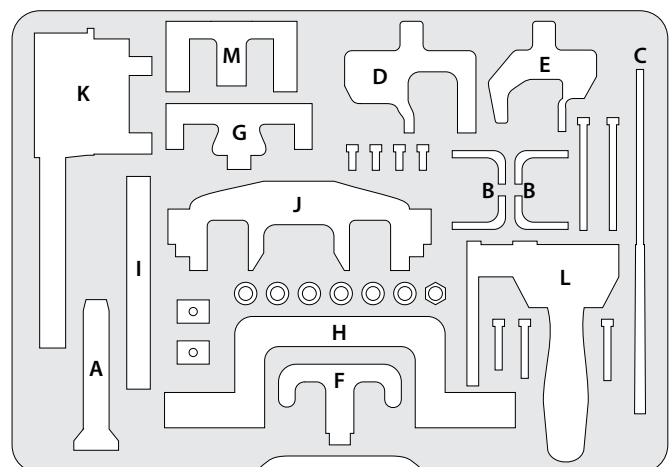

CAMSHAFT LOCKING KIT 

- Suitable for 6.2L (M156) V8 DOHC 32V engine applications with timing chains
- For the locking and alignment of the camshafts and CMP unit during the removal and installation of the engine timing chain and other engine servicing and repairs



APPLICATION LIST*

Part No.	Make & Model	Engine	Year
304751	Mercedes		
	C63 AMG	6.2L (M156)	2008 - 2015
	E63 AMG	6.2L (M156)	2006 - 2012
	ML63 AMG	6.2L (M156)	2006 - 2012
	S63 AMG	6.2L (M156)	2007 - 2011

CONTENTS

Tool Ref.	Toledo Tool No.	OEM Tool No.	Description
A	A0678	156 589 00 61 00	Camshaft Holding & Alignment Tool
B	A0679	156 589 00 32 00	CMP Sensor Setting Tool
C	A0680	156 589 01 63 00	Camshaft Clamping Tool

TOOL REFERENCE

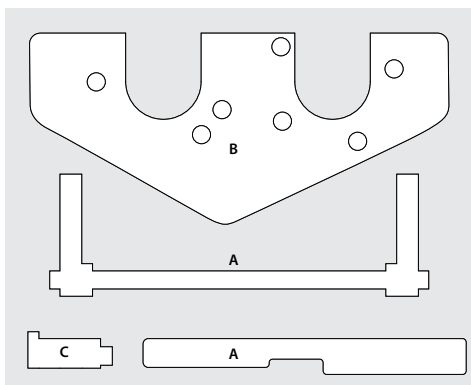

CAMSHAFT LOCKING KIT 

- Suitable for popular 1.6L & 2.0L (M133, M270 & M274) DOHC 16V direct injection petrol engine applications
- For the locking and alignment of the camshafts during the removal and installation of the engine timing chain and other engine servicing and repairs



APPLICATION LIST*

Part No.	Make & Model	Engine	Year
304761	Mercedes		
	A180, A200, A250	1.6L - 2.0L (M270)	2013 - 2018
	A45 AMG	2.0L (M133)	2013 - 2016
	B180, B200, B250	1.6L - 2.0L (M270)	2012 - 2018
	C180, C200, C250	1.6L - 2.0L (M274)	2013 - 2018
	CLA200, CLA250	1.6L - 2.0L (M270)	2013 - 2018
	CLA45 AMG	2.0L (M133)	2013 - 2016
	E200, E250	2.0L (M274.920)	2013 - 2018
	GLA180, GLA250	1.6L - 2.0L (M270)	2014 - 2018
	GLA45 AMG	2.0L (M133)	2014 - 2018

CONTENTS

Tool Ref.	Toledo Tool No.	OEM Tool No.	Description
A	A0712	270 589 01 61 00	Camshaft Holding /Alignment Tool A
B	A0713	270 589 01 61 00	Camshaft Holding /Alignment Tool B
C	A0714	270 589 01 61 00	Camshaft Blocks x 4 (Small)
D			Security Bit Socket

TOOL REFERENCE

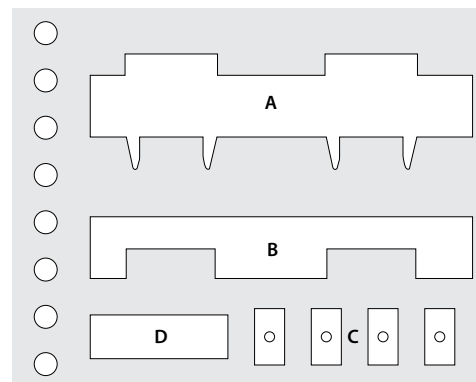

TIMING TOOL KIT

- Suitable for Mercedes 1.8L - 2.1L (OM651) diesel engine applications
- For the locking and alignment of the camshafts during the removal and installation of the engine timing chain and other engine servicing and repairs



APPLICATION LIST*

Part No.	Make & Model	Engine	Year
304768	Mercedes		
	A-Class (A200 CDI)	1.8L (OM651)	2013 - 2016
	B-Class (B200 CDI)	1.8L (OM651.901)	2012 - 2015
	C-Class (C200 CDI)	2.1L (OM651.913)	2011 - 2014
	C-Class (C250D)	2.1L (OM651)	2011 - 2018
	C-Class (C300H)	2.1L (OM651.921)	2014 - 2018
	CLA-Class (CLA200 CDI)	1.8L (OM651.901)	2014 - 2016
	CLS-Class (CLS250 CDI)	2.1L (OM651.924)	2012 - 2016
	E-Class (E220 CDI)	2.1L (OM651.924)	2009 - 2012
	E-Class (E250 CDI)	2.1L (OM651.924)	2009 - 2018
	E-Class (E300)	2.1L (OM651.924)	2013 - 2018
	GLA-Class (GLA200 CDI)	2.1L (OM651.930)	2014 - 2016
	ML-Class (ML250 CDI BLUETEC)	2.1L (OM651.960)	2012 - 2015
	Sprinter (313 - 516 CDI)	2.1L (OM651)	2010 - 2018
	Vito (110 - 116 CDI)	2.1L (OM651.940)	2011 - 2018

CONTENTS

Tool Ref.	Toledo Tool No.	OEM Tool No.	Description
A	A0745	651589094000	Camshaft Alignment Tools
B	A0746	651589004000	Crankshaft Holding / Turning Tool
C	A0747	651589026300	Balancer Shaft Alignment Tool
D	A0748	651589014000	Camshaft Alignment Tools
E	A0749	651589034000	Timing Chain To Camshaft Sprocket Holder
F	A0758	651589104000	Crankshaft Holding / Turning Tool

TOOL REFERENCE

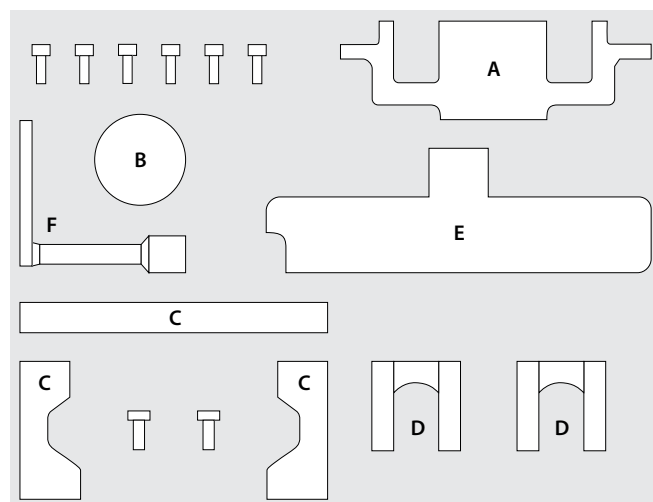

TIMING TOOL KIT 

- Suitable for popular 1.6L SOHC 16V (W10 & W11) petrol engine applications
- For the locking of the camshaft during the removal and installation of the engine timing chain and other engine servicing and repairs



APPLICATION LIST*

Part No.	Make & Model	Engine	Year
304703	MINI		
	Cooper (R50)	1.6L (W10 B16A)	2002 - 2007
	Cooper S (R50 - R53)	1.6L (W11 B16)	2002 - 2009
	One (R50)	1.6L (W10 B16A)	2001 - 2006

CONTENTS

Tool Ref.	Toledo Tool No.	OEM Tool No.	Description
A	A0068		Engine Support Bracket Bolts
B	A0164	11 8 240	Tensioner Assembly Tool
C	A0195	11 8 370	Engine Support Bracket
D	A0261	11 8 250	Camshaft Sprocket Holding Tool

TOOL REFERENCE

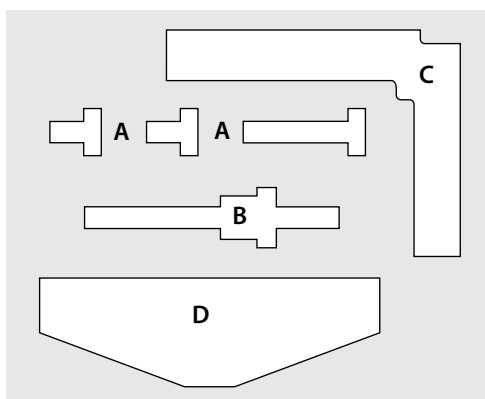

Also suitable: Part No. 304718
TIMING TOOL KIT



- Suitable for popular MINI 1.6L N12, N14 & N16 petrol engine applications
- **For full kit contents refer to page 173**



Also suitable: Part No. 304719
TIMING TOOL KIT



- Suitable for popular 2.0L (N47 & N57) DOHC 16V diesel engine applications
- For the locking and alignment of the camshafts, crankshaft, tensioner and injection pump during the removal and installation
- **For full kit contents refer to page 136**



Also suitable: Part No. 304758
TIMING TOOL KIT



- Suitable for popular Mini Cooper and Countryman, 1.6L petrol engine applications
- **For full kit contents refer to page 137**



Also suitable: Part No. 304763
TIMING TOOL KIT



- Suitable for popular Mini Cooper S and One, 1.2L - 2.0L petrol engine applications
- **For full kit contents refer to page 140**



Also suitable: Part No. 304785
TIMING TOOL KIT



- Suitable for popular Mini Cooper S and One, 1.2L - 1.5L engine applications
- **For full kit contents refer to page 141**



TIMING TOOL KIT



- Universal timing tool kit contains a comprehensive range of pulley holding and pulling tools suitable for popular Mitsubishi and Toyota applications
- For the locking and alignment of the camshafts, crankshaft and tensioner during the removal and installation of the engine timing belt, chain and other engine servicing and repairs



TOOL REFERENCE



Part No.	Description
304733	Timing tool kit

CONTENTS

Tool Ref.	Toledo Tool No.	OEM Tool No.	Description
1	XB 990757	Mitsubishi	Crankshaft Pulley Holder Tool
2	09330-0021	Toyota	Companion Flange Holding Tool
3	09278-54012	Toyota	Variable Pin Wrench
4	09223-15030	Toyota	Crankshaft Rear Oil Seal Replacer
5	09213-54015	Toyota	Crankshaft Pulley Holding Tool
6	09213-14010	Toyota	Camshaft Pulley Holding Tool
7	09951-05010	Toyota	Hanger 150

Tool Ref.	Toledo Tool No.	OEM Tool No.	Description
7, 14-29	09951-50013	Toyota	SST Pullers
8			Bolts - M8 x 65 (x2)
9			Bolts - M8 x 116 (x2)
10			Bolts - M8 x 106 (x2)
11			Bolts - M8 x 88 (x2)
12			Bolts - M8 x 80 (x2)
13			Bolts - M8 x 55 (x2)
14	09954-05561	Toyota	Bolts - M6 x 100 (x2)
15	09954-05551	Toyota	Bolts - M6 x 30 (x2)
16	09957-04010	Toyota	Attachment
17	09555-05010	Toyota	Adapter Screw M10 x 1.25 (x2)
18	09555-05020	Toyota	Adapter Screw M10 x 1.5 (x2)
19	09555-05030	Toyota	Adapter Screw M12 x 1.25 (x2)
20	09555-05040	Toyota	Adapter Screw M12 x 1.5 (x2)
21	09954-05070	Toyota	Bolts - M8 x 75 (x2)
22	09954-05521	Toyota	Bolts - M8 x 50 (x2)
23	09954-05541	Toyota	Bolts - M8 x 150 (x2)
24	09954-05011	Toyota	Bolts - M5 x 100 (x2)
25	09954-05531	Toyota	Bolts - M8 x 100 (x2)
26	09954-05080	Toyota	Bolts - M8 x 225 (x2)
27	09953-05010	Toyota	Centre Bolt 100mm
28	09953-05020	Toyota	Centre Bolt 150mm
29	09952-05010	Toyota	Slide Arm
30	XD 998738	Mitsubishi	Spanner Tool Belt Adjustment Screw
31	XD 998767	Mitsubishi	Camshaft Pulley Holder Tool



CAMSHAFT BELT TENSIONER LOCKING TOOLS 

- Suitable for popular 1.6L – 3.8L petrol engine applications
- For the locking and alignment of the automatic tensioner during removal and installation of the engine timing belt



APPLICATION LIST*

Part No.	Make & Model	Engine	Year
304748	Hyundai		
	Lantra (J1 - J3)	1.6L - 1.8L (G4)	1991 - 2000
	Kia		
	Sorento (BL)	3.5L (G6CU)	2003 - 2009
	Mitsubishi		
	380 (DB)	3.8L (6G75)	2005 - 2008
	Express / Starwagon	2.0L - 3.0L	1994 - 2006
	Lancer (CG - CJ)	2.0L	2002 - 2015
	Magna (TS - TW)	3.0L - 3.5L	1994 - 2005
	Outlander (ZE - ZH)	2.4L	2003 - 2012
	Pajero (NL - NP)	3.5L - 3.8L	1997 - 2006
	Triton (MK - ML)	2.4L - 3.5L	1996 - 2011

CONTENTS

Tool Ref.	Toledo Tool No.	OEM Tool No.	Description
A	A0555	MD998752, MB998767, 09241-28100	Tensioner Pulley Holding Tool
B	A0001		Tensioner Locking Pin
C	A0470		Locking Pin
D	A0556	MD998738, 09244-28000	Automatic Tensioner Tool Holding Screw

TOOL REFERENCE

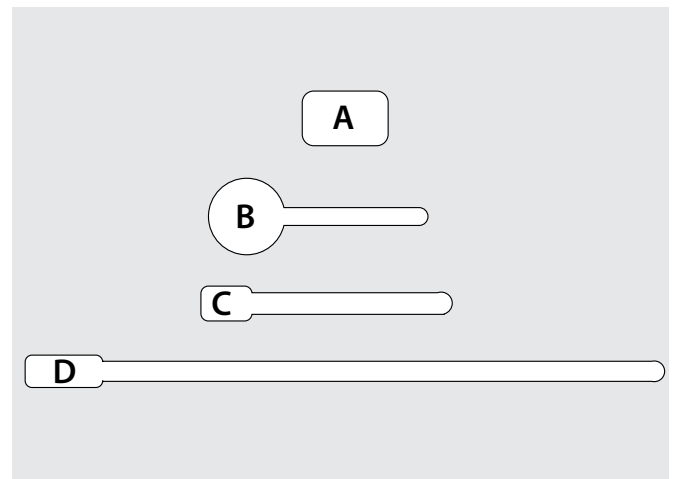

TIMING TOOL KIT

- Suitable for popular 2.0L (M9R) and 2.3L (YS23) diesel engine applications
- For the locking and alignment of the camshafts, crankshaft and tensioner during the removal and installation



APPLICATION LIST*

Part No.	Make & Model	Engine	Year
304745	Nissan		
	Navara (D23, NP300)	2.3L (YS23DDT)	2015 - 2018
	Navara (D23, NP300)	2.3L (YS23DDTT)	2015 - 2018
	X-Trail (T31)	2.0L (M9R)	2008 - 2014
	Renault		
	Koleos (H45)	2.0L (M9R)	2008 - 2016
	Koleos (H45)	2.5L (2TR 70)	2008 - 2016
	Laguna	2.0L (M9R)	2008 - 2011
	Latitude (X43)	2.0L (M9RM)	2011 - 2016
	Master (X62)	2.3L (M9T)	2011 - 2018
	Megane (Sport dCi)	2.0L (M9RC)	2007 - 2015

CONTENTS

Tool Ref.	Toledo Tool No.	OEM Tool No.	Description
A	A0109	-	Auxiliary Belt Tensioner Locking Pin
B	A0535	MOT1770/EN48334	Crankshaft Pulley Holding Tool
C	A0536	MOT1769/EN48332	Camshaft Setting Tool
D	A0537	MOT1773/EN48331	Camshaft Gear Alignment Bracket
E	A0538	MOT1766/EN48330	Crankshaft Locking Pin
F	A0539	-	Tensioner Locking Pin
G	A0540	-	Bolt
H	A0541	-	Hex Key

TOOL REFERENCE

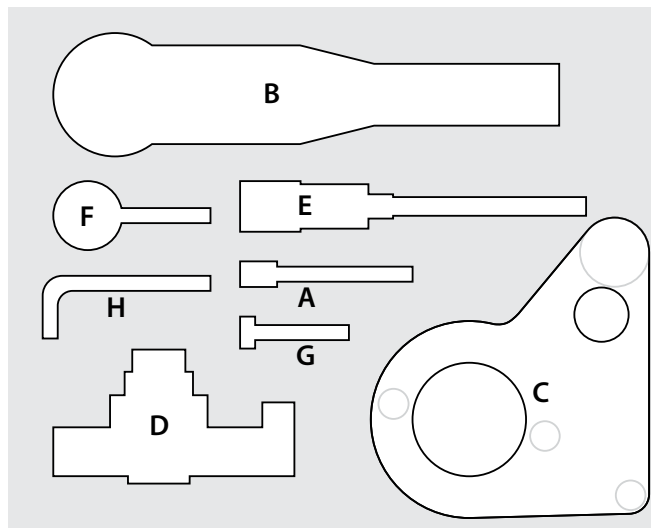

TIMING TOOL KIT  

- Suitable for popular 1.4L – 2.2L petrol and 1.5L – 2.2L diesel engine applications
- For the locking of the camshafts and crankshaft during the removal and installation of the engine timing belt and other engine servicing and repairs



APPLICATION LIST*

Part No.	Make & Model	Engine	Year
304704	Citroen		
	Berlingo, C2, C3, C4	1.6L (TU5JP4)	2003 - 2014
	C4, C5, Xsara	2.0L (EW10)	2001 - 2010
	C4, C5	2.0L (DW10BTED4)	2005 - 2012
	C5 (2.0 HDI 110)	2.0L (DW10ATED)	2001 - 2005
	C5 (2.2 HDI)	2.2L (DW12BTED4)	2007 - 2008
	Dispatch (G9C)	2.0L (DW10UTED4)	2008 - 2011
	Xsara	1.6L (TU5JP4)	2001 - 2005
	Peugeot		
	206 (XR)	1.4L (TU3JP)	1999 - 2007
	206, 307	1.6L (TU5JP)	1999 - 2008
	206 GTi, 307	2.0L (EW10J4,S)	1999 - 2009
	207 (XR)	1.4L (ET3J4)	2007 - 2010
	306 (NS)	1.8L (XU7JP)	1997 - 2001
	306, 406	2.0L (XU10J4)	1996 - 2004
	307 (XS HDi)	1.6L (DV6TED4)	2005 - 2008
	307 (NS)	2.0L (DW10TD)	2001 - 2005
	307, 308, 407, Expert	2.0L (DW10BTED4)	2004 - 2014
	308, 407, 5008, Expert, RCZ	2.0L (DW10CTED4)	2008 - 2018
	3008 (2.0 HDi)	2.0L (DW10CTED4)	2010 - 2018
	406 (D9)	2.0L (DW10ATED)	1999 - 2004
	407 (ST)	2.2L (EW12J4)	2004 - 2009
	4007 (ST, SV)	2.2L (DW12MTED4)	2009 - 2014
	508 (GT HDi)	2.2L (DW12)	2011 - 2015
	Partner	1.6L (TU5JP4B)	2008 - 2018

TOOL REFERENCE

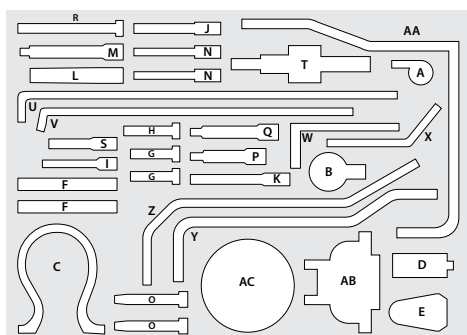

CONTENTS

Tool Ref.	Toledo Tool No.	OEM Tool No.	Description
A	A0007	4200-TH	Tensioner Pulley Locking Pin
B	A0008	0188-AH	Crankshaft Sprocket Centralizing Tool
C	A0019	0189-K, 4533-TAD	Timing Belt Retaining Clip
D	A0029	0134-Q	Flywheel Locking Tool
E	A0031	0153-A, 6012-T, 9765 54, D86	Flywheel Locking Tool
F	A0050	0132-R, 0153-AB, 0153-G, 4507-TB	Camshaft & Flywheel Timing Pins
G	A0070	M8 x 1.25 x 30mm	Bolt
H	A0071	M8 x 1.25 x 40mm	Bolt
I	A0081	0132-AJ1, 0178-C, 0188-H, 0195C, 4533-TAC1	Camshaft Timing Pin
J	A0083	0194-B, 21-263, 303-735, 999 7122	Camshaft Sprocket Locking Pin
K	A0087	4533-TAC1, 4533-TAC2	Camshaft Locking Pin
L	A0089	21-262, 303-734, 999 7121	Crankshaft Locking Pin
M	A0090	0189-L, 0189-AZ	Camshaft Timing Pin
N	A0107	0132-AB, 0194-A, 07744-0010400, 21-260, 303-732, 999 7169, 999 7233	Crankshaft Locking Pins
O	A0117	0178-C, 0178-D	Injection Pump Timing Pins
P	A0119	0189-A	Camshaft Timing Pin
Q	A0120	0189-AZ	Camshaft Timing Pin
R	A0126	M8 x 1.25	Bolt
S	A0135	0132-RZ	Camshaft Timing Pin
T	A0182	0189-R	Flywheel Locking Tool
U	A0199	0189-S2	Tensioner Pulley Locking Tool
V	A0200	0189-S2	Tensioner Pulley Locking Tool
W	A0202	0132-X, 4507-TJ	Auxiliary Belt Tensioner Setting Tool
X	A0224	0132-Q, 4507-TA	Crankshaft Timing Pin
Y	A0227	0153-N, 7004-TG, 7014-TJ, 7017-TR, 9767 34	Crankshaft Timing Pin
Z	A0228	7017-TR	Flywheel Timing Pin
AA	A0229	0153-N, 7099-TM, 7017-TR, 9767 34	Flywheel Timing Pin
AB	A0256	7015-T (0174)	Crankshaft Pulley Puller
AC	A0386	0189-S1	Tensioner Pulley Adjusting Tool

TIMING TOOL KIT

- Suitable for popular 2.0L (DW10) diesel engine applications
- For the locking and alignment of the camshafts, crankshaft and tensioner during the removal and installation of the engine timing belt, chain and other engine servicing and repairs



APPLICATION LIST*

Part No.	Make & Model	Engine	Year
304721	Citroen		
	C4, C4 Picasso, C5 (2.0 HDi)	2.0L (DW10)	2001 - 2018
	C5 (2.2 HDi)	2.2L (DW12)	2005 - 2018
	Dispatch (G9C)	2.0L (DW10UTED4)	2008 - 2011
	DS5 (Dsport HDi)	2.0L (DW10CTED4)	2013 - 2015
	Xsara	2.0L (DW10TD)	2000 - 2005
	Peugeot		
	307, 308, 3008 (2.0 HDi)	2.0L (DW10)	2001 - 2018
	406, 407 (2.0 HDi)	2.0L (DW10)	1999 - 2011
	4007 (2.2 HDi)	2.2L (DW12MTED4)	2009 - 2014
	508 (2.0 HDi)	2.0L (DW10CTED4)	2011 - 2018
	508 (2.2 HDi)	2.2L (DW12)	2011 - 2015
	RCZ (2.0 HDi)	2.0L (DW10CTED4)	2010 - 2015
	4007 (HDi)	2.2L (DW12MTED4)	2009 - 2012
	RCZ (HDi)	2.0L (DW10CTED4)	2010 - 2012

CONTENTS

Tool Ref.	Toledo Tool No.	OEM Tool No.	Description
A	A0007	0153-AL	Tensioner Pulley Locking Pin
B	A0008	0188-AH	Crankshaft Sprocket Centralizing Tool
C	A0019	0188-K	Timing Belt Retaining Clip
D	A0029	0188-F	Crankshaft Locking Tool
E	A0047	M8 x 1.25	M8 x 70mm Set screw
F	A0071	M8 x 1.25 x 40mm	Bolt
G	A0087	0188-M	Camshaft Locking Pin
H	A0201	0188-Q1, 0188-Q2, 0188-Z	Cambelt Tensioner
I	A0215	0188-X	Crankshaft Timing Pin
J	A0227	0188-Y	Flywheel Timing Pin
K	A0229	0153-N, 0188-D, 0288-D, 7099-TM	Flywheel Timing Pin
L	A0230	7004-TG	Camshaft Timing Pin
M	A0256	0188-P	Crankshaft Pulley Puller
N	A0313	0132-AA, 6016-T	Camshaft Adjusting Wrench
O	A0345	0188-J2	Tensioning Tool

TOOL REFERENCE

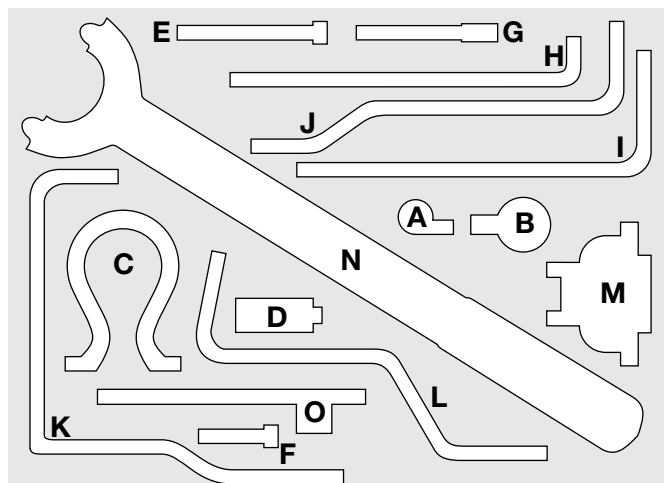

TIMING TOOL KIT 

- Suitable for 1.6L (EP6, N12 & N14) DOHC 16V petrol engine applications
- For the locking and alignment of the camshafts, crankshaft and tensioner during the removal and installation of the engine timing chain and other engine servicing and repairs



APPLICATION LIST*

Part No.	Make & Model	Engine	Year
304718	Citroen		
	C3, DS3	1.4L, 1.6L (EP3, EP6)	2010 - 2015
	C4, DS4, C5, DS5	1.6L (EP6)	2009 - 2018
	MINI		
	Cooper	1.6L (N12, N16)	2007 - 2018
	Cooper (S, JCW)	1.6L (N14)	2007 - 2018
	Countryman	1.6L	2011 - 2017
	Peugeot		
	207, 308	1.4L (EP3)	2010 - 2013
	207, 208, 2008, 308	1.6L (EP6)	2007 - 2017
	207 (GT), 207CC, 308, 3008, 508	1.6L (EP6DT)	2007 - 2018
	508 (ACTIVE)	1.6L (EP6FDT)	2015 - 2018
	5008 (1.6T)	1.6L (EP6CDT)	2013 - 2015
	RCZ	1.6L (EP6CDT)	2010 - 2015

CONTENTS

Tool Ref.	Toledo Tool No.	OEM Tool No.	Description
A	A0072		Camshaft Alignment Kit (Bolts)
B	A0170	11 9 340	Timing Chain Pre-Tensioning Tool
C	A0208	0197-B, 11 9 590	Crankshaft Timing Pin
D	A0429	11 9 552	Camshaft Alignment Kit
E	A0450	0197-A3, 11 9 540	Camshaft Alignment Tool
F	A0451	0197-A2, 0197-A3, 11 9 550	Camshaft Alignment Tool
G	A0452	0197-A1, 11 9 540, 11 9 550	Camshaft Alignment Tool

TOOL REFERENCE

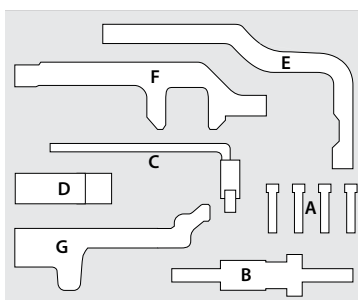

TIMING TOOL KIT 

- Suitable for popular 1.4L – 2.0L SOHC 8V and DOHC 16V petrol engine applications
- For the locking and alignment of the camshafts, crankshaft and tensioner during the removal and installation of the engine timing belt and other engine servicing and repairs



APPLICATION LIST*

Part No.	Make & Model	Engine	Year
304726	Citroen		
	Berlingo, C2, C3, C4	1.4L - 2.0L	2003 - 2010
	Ford		
	Fiesta	1.6L (TDCi)	2009 - 2012
	Peugeot		
	307, 307CC	2.0L (EW10A)	2005 - 2009
	Volvo		
	C30	1.6L (Diesel)	2009 - 2012

CONTENTS

Tool Ref.	Toledo Tool No.	OEM Tool No.	Description
A	A0007	4200-TH	Tensioner Pulley Locking Pin
B	A0019	0189-K, 4533-TAD	Timing Belt Retaining Clip
C	A0050	0132-R, 0153-AB, 0153-G, 4507-TB	Camshaft Timing Pin
D	A0083	0194-B, 21-263, 303-735, 999 7122	Camshaft Timing Pin
E	A0087	4533-TAC1, 4533-TAC2	Camshaft Timing Pin
F	A0089	21-262, 303-734, 999 7121	Flywheel Locking Tool
G	A0107	0132-AB, 0194-A, 07744-0010400, 21-260, 303-732, 999 7169, 999 7233	Camshaft Timing Pins
H	A0182	0189-R	Flywheel Locking Tool
I	A0199	0189-S2	Tensioner Pulley Locking Tool
J	A0224	0132-Q, 4507-TA	Flywheel Locking Tool
K	A0386	0189-S1	Tensioner Pulley Adjusting Tool

TOOL REFERENCE

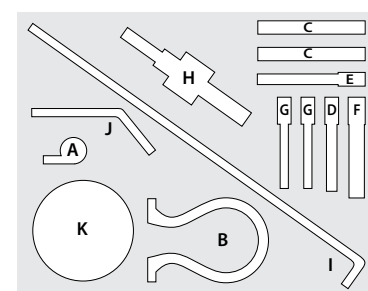

TIMING TOOLS

PORSCHE

Also suitable: Part No. 304735

TIMING TOOL KIT



- Suitable for popular Porsche Cayenne 3.0L diesel engine applications
- For full kit contents refer to page 128



Also suitable: Part No. 304756

TIMING TOOL KIT



- Suitable for popular Porsche Cayenne 3.6L (M55) petrol engine applications
- For full kit contents refer to page 130



RANGE ROVER

Also suitable: Part No. 304746

TIMING TOOL KIT



- Suitable for popular Range Rover, Sport 2.7L & 3.0L diesel engine applications
- For full kit contents refer to page 162



Also suitable: Part No. 304784

FUEL PUMP LOCKING TOOL



- Suitable for popular Range Rover, Sport 2.7L & 3.0L diesel engine applications
- For full kit contents refer to page 162



RENAULT

Also suitable: Part No. 304745

TIMING TOOL KIT



- Suitable for popular 2.0L (M9R) and 2.3L (YS23) diesel engine applications
- For the locking and alignment of the camshafts, crankshaft and tensioner during the removal and installation
- For full kit contents refer to page 170



Scan here for link to part finder

TIMING TOOL MASTER KIT 

- Suitable for popular 1.4L – 2.0L DOHC 16V petrol engine applications
- For the locking and alignment of the camshafts, crankshaft and tensioner during the removal and installation of the engine timing belt and other engine servicing and repairs



APPLICATION LIST*

Part No.	Make & Model	Engine	Year
304727	Renault		
	Clio	1.4L (K4J)	2000 - 2008
	Clio	1.6L (K4M)	2002 - 2008
	Clio	2.0L (F4R)	2000 - 2018
	Grand Scenic	2.0L (F4R)	2005 - 2010
	Kangoo	1.6L (K4M)	2004 - 2018
	Laguna	2.0L (F4R)	2002 - 2011
	Megane	1.6L (K4M)	1999 - 2007
	Megane	2.0L (F4R)	2003 - 2018
	Scenic	1.6L (K4M)	2001 - 2002
	Scenic	2.0L (F4R)	2001 - 2007

CONTENTS

Tool Ref.	Toledo Tool No.	OEM Tool No.	Description
A	A0095	MOT 1054	Crankshaft Locking Pin
B	A0136	MOT 1489	Crankshaft Timing Pin
C	A0191		Guide Pin
D	A0243	MOT 1496, MOT 1750	Camshaft Setting Bar
E	A0313	MOT 799-01	Camshaft Adjusting Wrench
F	A0360	MOT 1490-01	Camshaft Sprocket Locking Tool
G	A0437	MOT 1509-01, MOT 1801	Camshaft Locking Tool
H	A0607	1 895 751 000, 1 895 751 023, A 95751, MOT 1273, MOT 1505, MOT 1638, MOT 1715	Auxiliary Drive Belt Tension Gauge
I	A0620	MOT 1368	Guide Pulley Wrench

TOOL REFERENCE

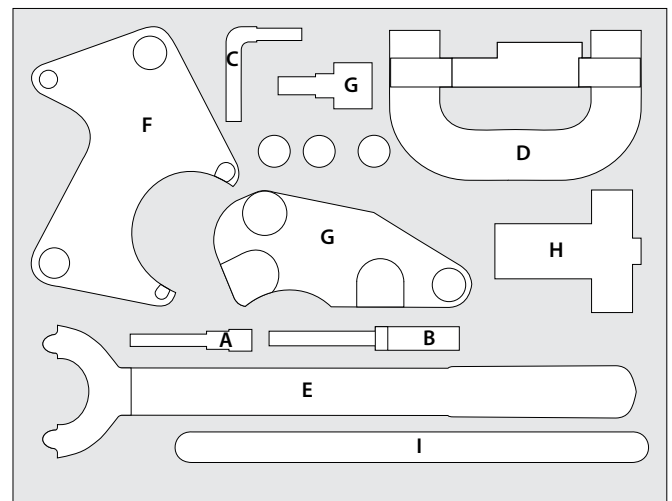

CAMSHAFT LOCKING KIT

- Suitable for SAAB 2.0L turbo engine applications
- For the locking and alignment of the camshafts and crankshaft during the removal and installation of the engine timing chain and other engine servicing and repairs



APPLICATION LIST*

Part No.	Make & Model	Engine	Year
304766	SAAB		
	9-3 (2.0)	2.0L (B207)	2004 - 2005
	9-3 (2.0T)	2.0L (B207E)	2005 - 2007
	9-3 (2.0T)	2.0L (B207L)	2002 - 2010
	9-3 (Bio Power)	2.0L (B207L)	2007 - 2010
	9-3 (Linear Sport)	2.0L (B207E)	2008 - 2009
	9-3 (Linear, Arc, Vector)	2.0L (B207)	2002 - 2007

CONTENTS

Tool Ref.	Toledo Tool No.	OEM Tool No.	Description
A	A0001	83 96 392	Tensioner Locking Pin
B	A0613	83 96 210	Crankshaft Pulley Holder
C	A0752	83 96 046, EN-48366	Camshaft Lock Tools

TOOL REFERENCE

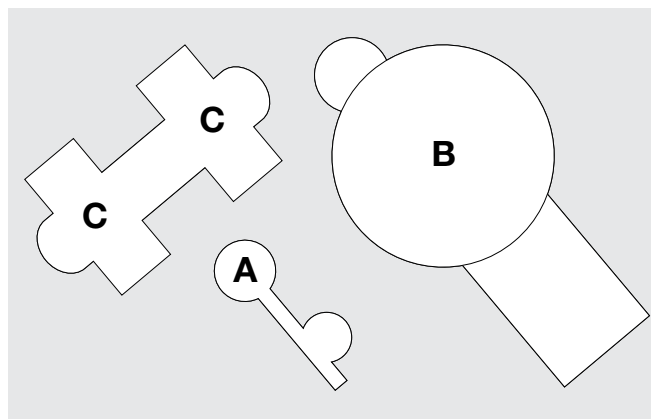

Also suitable: Part No. 304714
TIMING TOOL KIT



- Suitable for popular Skoda Octavia 2.0 petrol engine applications
- For full kit contents refer to page 124



Also suitable: Part No. 304715
TIMING TOOL KIT



- Suitable for popular Skoda Octavia, Roomster, Superb, Yeti applications
- For full kit contents refer to page 125



Also suitable: Part No. 304716**TIMING TOOL KIT**

- Suitable for popular Skoda Fabia, Octavia, Rapid, Roomster & Yeti applications
- For full kit contents refer to page 126

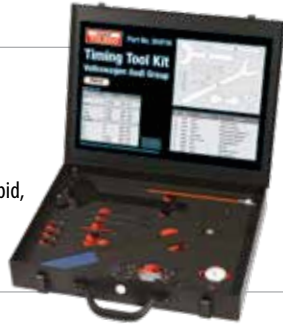
**Also suitable: Part No. 304725****TIMING TOOL KIT**

- Suitable for popular Skoda Octavia, Roomster, Superb & Yeti diesel engine applications
- For full kit contents refer to page 127

**Also suitable: Part No. 304728****TIMING TOOL KIT**

- Suitable for popular Skoda Fabia & Octavia applications
- For full kit contents refer to page 128

**Also suitable: Part No. 304750****TIMING TOOL KIT**

- Suitable for popular Skoda Octavia 1.8L & 2.0 petrol engine applications
- For full kit contents refer to page 129

**Also suitable: Part No. 304757****TIMING TOOL KIT**

- Suitable for popular Skoda Octavia, Roomster, Superb & Yeti petrol engine applications
- For full kit contents refer to page 131

**Also suitable: Part No. 304765****TIMING TOOL KIT**

- Suitable for popular Skoda Octavia 1.6L & 2.0 diesel engine applications
- For full kit contents refer to page 132

**Also suitable: Part No. 304709****TIMING TOOL KIT**

- Suitable for popular Actyon, Kyron, Rexton & Stavic applications
- For the locking and alignment of the camshafts, crankshaft and tensioner during the removal and installation of the engine timing chain and other engine servicing and repairs
- For full kit contents refer to page 164



TIMING TOOL KIT

- Universal timing tool kit contains a comprehensive range pulley holding and pulling tools suitable for popular Australian, Japanese and Korean applications
- For the locking and alignment of the camshafts, crankshaft, tensioner during the removal and installation of the engine timing belt, chain and other engine servicing and repairs



TOOL REFERENCE

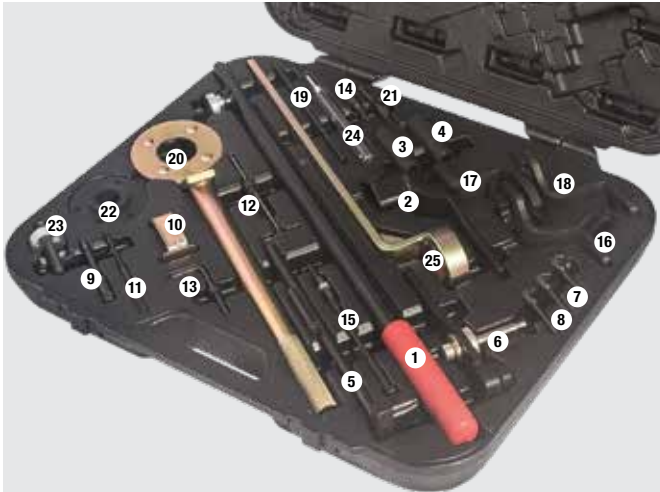

Part No.	Description
304734	Timing tool kit

CONTENTS

Tool Ref.	Toledo Tool No.	OEM Tool No.	Description
1	07-JAB-001020B	Honda	Handle Holder Crank Pulley
2	07-MAB-PY-30100	Honda	Holder Attachment Crank Pulley
3	JAA0010100V17	Honda	17mm Socket
4	JAA0010100V19	Honda	19mm Socket
5	18G1521	Honda	Camshaft Holder Tool
6	JAB-0010100	Honda	Tool Holder
7	18G1523	Honda	Flywheel Fixed Pin
8	18G1717A	Honda	Injection Pump Pin
9	07 LAG-PT 20100	Honda	Balance Shaft Fixed Pin
10	14540-P13-003	Honda	Clamp
11	07744-0010400	Honda	Driver Pin (5.0mm)
12	18G1719	Honda	Fixed Bolt
13	09244-28100	Hyundai / Mitsubishi	Locking Pin 3 x 112mm
14	09244-28100	Hyundai / Mitsubishi	Connecting Pin 14 x 55mm
15	09244-28000	Hyundai	Belt Spanner
16	KM 42 A	Daewoo / Holden	Water Pump Wrench (SW41)
17	MKM 472	Daewoo / Holden	Water Pump Wrench (SW46)
18	J 42492	Daewoo / Holden	Water Pump Wrench (SW40)
19	49 JE 01064	Mazda	Camshaft Holder Tool
20	499977000	Subaru	Crankshaft Pulley Holder
21	49 JE 01061	Mazda	OT Fixed Pin
22	49 JE 01002	Mazda	Pulley Holder
23	49 JE 01062	Mazda	Crankshaft Pulley Tool
24	49 JE 01050	Mazda	Crankshaft Pin
25	49 DO 11102	Mazda	Crankshaft Holder Tool



CAMSHAFT LOCKING TOOL

- Suitable for popular Subaru 2.0L & 2.5L petrol engine applications
- For locking the camshafts during the removal and installation of the engine timing belt and other engine servicing and repairs
- Manufactured from high quality aluminium
- OEM reference No. 499207300 (12 point hex)



Part No.	Description
304780	Camshaft Locking Tool

CAMSHAFT LOCKING TOOL

- Suitable for popular Subaru 2.0L and 2.5L DOHC Turbo petrol engine applications
- For locking the camshafts during the removal and installation of the engine timing belt and other engine servicing and repairs



Part No.	Description
304781	Camshaft Locking Tool

TIMING TOOL KIT



- Universal timing tool kit contains a comprehensive range of pulley holding and pulling tools suitable for popular Mitsubishi and Toyota applications
- For the locking and alignment of the camshafts, crankshaft and tensioner during the removal and installation of the engine timing belt, chain and other engine servicing and repairs



TOOL REFERENCE



Part No.	Description
304733	Timing tool kit

CONTENTS

Tool Ref.	Toledo Tool No.	OEM Tool No.	Description
1	XB 990757	Mitsubishi	Crankshaft Pulley Holder Tool
2	09330-0021	Toyota	Companion Flange Holding Tool
3	09278-54012	Toyota	Variable Pin Wrench
4	09223-15030	Toyota	Crankshaft Rear Oil Seal Replacer
5	09213-54015	Toyota	Crankshaft Pulley Holding Tool
6	09213-14010	Toyota	Camshaft Pulley Holding Tool
7	09951-05010	Toyota	Hanger 150

Tool Ref.	Toledo Tool No.	OEM Tool No.	Description
7, 14-29	09951-50013	Toyota	SST Pullers
8			Bolts - M8 x 65 (x2)
9			Bolts - M8 x 116 (x2)
10			Bolts - M8 x 106 (x2)
11			Bolts - M8 x 88 (x2)
12			Bolts - M8 x 80 (x2)
13			Bolts - M8 x 55 (x2)
14	09954-05561	Toyota	Bolts - M6 x 100 (x2)
15	09954-05551	Toyota	Bolts - M6 x 30 (x2)
16	09957-04010	Toyota	Attachment
17	09555-05010	Toyota	Adapter Screw M10 x 1.25 (x2)
18	09555-05020	Toyota	Adapter Screw M10 x 1.5 (x2)
19	09555-05030	Toyota	Adapter Screw M12 x 1.25 (x2)
20	09555-05040	Toyota	Adapter Screw M12 x 1.5 (x2)
21	09954-05070	Toyota	Bolts - M8 x 75 (x2)
22	09954-05521	Toyota	Bolts - M8 x 50 (x2)
23	09954-05541	Toyota	Bolts - M8 x 150 (x2)
24	09954-05011	Toyota	Bolts - M5 x 100 (x2)
25	09954-05531	Toyota	Bolts - M8 x 100 (x2)
26	09954-05080	Toyota	Bolts - M8 x 225 (x2)
27	09953-05010	Toyota	Centre Bolt 100mm
28	09953-05020	Toyota	Centre Bolt 150mm
29	09952-05010	Toyota	Slide Arm
30	XD 998738	Mitsubishi	Spanner Tool Belt Adjustment Screw
31	XD 998767	Mitsubishi	Camshaft Pulley Holder Tool



Also suitable: Part No. 304714

TIMING TOOL KIT



- Suitable for popular Volkswagen Beetle, Bora, Caddy, EOS, Golf, Jetta, Passat, Scirocco Transporter petrol engine applications

■ For full kit contents refer to page 124



Also suitable: Part No. 304715

TIMING TOOL KIT



- Suitable for popular Volkswagen Amarok, Beetle, Bora, Caddy, EOS, Golf, Jetta, Passat, Polo & Transporter applications

■ For full kit contents refer to page 125



Also suitable: Part No. 304716

TIMING TOOL KIT



- Suitable for popular Volkswagen Beetle, Golf, Jetta, Polo & Tiguan 1.4L & 1.6L petrol engine applications

■ For full kit contents refer to page 126



Also suitable: Part No. 304725

TIMING TOOL KIT



- Suitable for popular Volkswagen Amarok, Beetle, Caddy, EOS, Golf, Jetta, Passat, Polo, Scirocco & Transporter applications

■ For full kit contents refer to page 127



Also suitable: Part No. 304728

TIMING TOOL KIT



- Suitable for Volkswagen popular Beetle, Caddy, Citivan, Golf, Polo and Transporter petrol engine applications

■ For full kit contents refer to page 128



TIMING TOOL KIT

- Suitable for popular 2.5L petrol and 2.4L, 2.5L diesel engine applications
- For the locking and alignment of the camshaft, crankshaft, tensioner and injection pump during the removal and installation of the engine timing belt and other engine servicing and repairs



APPLICATION LIST*

Part No.	Make & Model	Engine	Year
304722	Volkswagen		
	Caravelle (IV)	2.5L	1993 - 2003
	Caravelle (IV)	2.5L (TDi)	2000 - 2005
	Crafter	2.5L (TDi)	2007 - 2012
	Kombi (IV)	2.5L	2003 - 2004
	LT 35	2.5L (TDi)	2003 - 2006
	LT 46	2.5L (TDi)	2003 - 2006
	Transporter (IV)	2.5L	1993 - 2004
	Transporter (IV)	2.4L, 2.5L (TDi)	1994 - 2006

CONTENTS

Tool Ref.	Toledo Tool No.	OEM Tool No.	Description
A	A0141	2064	Injection Pump Setting Pin
B	A0178	3313	Dial Gauge Adaptor
C	A0189	40001	Camshaft Sprocket Puller
D	A0313	3036	Camshaft Adjusting Wrench
E	A0320	3355	Tensioner Pulley Spanner
F	A0342	3248A, T10025	Crankshaft Damper Holding Tool
G	A0409	3313	Dial Gauge
H	A0425	2065A	Camshaft Setting Bar
I	A0453	3212	Pulley Holding Tool
J	A0468	50009	Crankshaft Timing Pin
K	A0607	1 895 751 000, 1 895 751 023, A 95751	Auxiliary Drive Belt Tension Gauge

TOOL REFERENCE

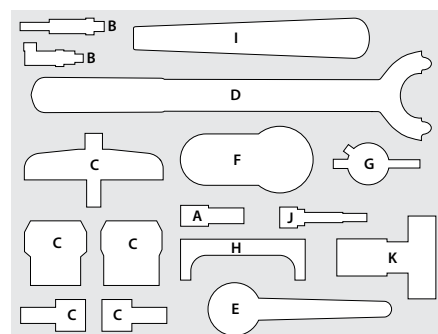

TIMING TOOL KIT

- Suitable for popular 2.5 & 4.9L TDI diesel engine applications
- For locking and alignment of the camshaft and crankshaft gears during servicing of the engine valve timing and other engine repairs



APPLICATION LIST*

Part No.	Make & Model	Engine	Year
304747	Volkswagen		
	Caravelle	2.5L (AXE, BNZ, BPC)	2004 - 2010
	Kombi (V)	2.5L (BNZ)	2006 - 2009
	Multivan (V)	2.5L (AXE, BPC)	2005 - 2010
	Phaeton	4.9L (AJS)	2004 - 2007
	Touareg	2.5L (BAC, BPE)	2004 - 2009
	Touareg	4.9L (AYH, BLE, CBW)	2004 - 2010
	Transporter	2.5L (AX, BNZ, BPC)	2004 - 2010

CONTENTS

Tool Ref.	Toledo Tool No.	OEM Tool No.	Description
A	A0546	T10193	Camshaft Locking Tool 1
B	A0547	T10194	Camshaft Locking Tool 2
C	A0548	T10195	Crankshaft Locking Tool
D	A0549	T10199	Camshaft Gear Retaining Tool 1
E	A0550	T10199/1	Camshaft Gear Retaining Tool 2
F	A0551	T10200	Guide Pin
G	A0552	T10225	Crankshaft Alignment Tool
H	A0553	T10226	Crankshaft Locking Tool
J	A0554	T10234	Camshaft Compensation Gear Pre-Tensioning Tool

TOOL REFERENCE

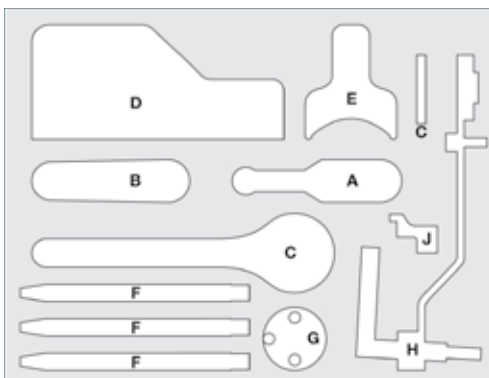

Also suitable: Part No. 304735

TIMING TOOL KIT



- Suitable for popular Volkswagen Touareg 3.0L & 4.2L diesel engine applications
- For full kit contents refer to page 128



Also suitable: Part No. 304750

TIMING TOOL KIT



- Suitable for popular Volkswagen Amarok, EOS, Golf, Jetta, Passat & Tiguan 1.8L & 2.0L petrol engine applications
- For full kit contents refer to page 129



Also suitable: Part No. 304756

TIMING TOOL KIT



- Suitable for popular Volkswagen Bora, Caravelle, Golf, Multivan, Passat & Transporter petrol engine applications
- For full kit contents refer to page 130



Also suitable: Part No. 304757

TIMING TOOL KIT



- Suitable for popular Volkswagen Caddy, Golf, Polo & UP 1.0L - 1.4L petrol engine applications
- For full kit contents refer to page 131



Also suitable: Part No. 304765

TIMING TOOL KIT



- Suitable for popular Volkswagen Golf 1.6L diesel engine applications
- For full kit contents refer to page 132



Also suitable: Part No. 304767

TIMING TOOL KIT



- Suitable for popular Volkswagen Touareg 4.2L petrol engine applications
- For full kit contents refer to page 133



Scan here for link to part finder

* Abbreviated applications to be used as a guide only, for complete vehicle application listings go to website tridon.com.au/partfinder

TIMING TOOL KIT 

- Suitable for popular 4, 5 and 6 cylinder DOHC petrol engine applications
- For the locking of camshafts during the removal and installation of the engine timing belt and other engine servicing and repairs

Note: Applications may require additional tools to complete repairs



APPLICATION LIST*

Part No.	Make & Model	Engine	Year
304737	Ford		
	Focus XRS Turbo (LS - LV)	2.5L (B5254T)	2006 - 2012
	Kuga (TE)	2.5L (Duratec)	2012 - 2013
	Mondeo XRS Turbo (MA - MB)	2.5L (B5254T)	2007 - 2014
	Volvo		
	850, 850(T)	2.3L, 2.4L (B52)	1992 - 1997
	960	2.9L (B630)	1991 - 1997
	C30, C30(T)	2.4L, 2.5L (B52)	2007 - 2013
	C70, C70(T)	2.3L - 2.5L (B52)	1999 - 2015
	S40, S40(T)	1.9L - 2.5L (B41, B42, B52)	1997 - 2013
	S60, S60(T)	2.0L - 2.5L (B52)	2000 - 2009
	S70, S70(T)	2.3L, 2.4L (B52)	1997 - 2003
	S80, S80(T)	2.0L - 2.9L (B52, B62, B63)	1998 - 2006
	V40, V40(T)	1.8L, 2.0L (B41, B42)	1997 - 2004
	V50, V50(T)	2.4L, 2.5L (B52)	2004 - 2015
	V70, V70(T)	2.0L - 2.5L (B52)	1997 - 2008
	XC70, XC70(T)	2.3L - 2.5L (B52)	2000 - 2007
	XC90, XC90(T)	2.5L - 2.9L (B52, B62)	2003 - 2006

BELT INSTALLATION KIT  

- Suitable for popular 1.9L – 2.5L DOHC petrol and 2.5L DOHC diesel engine applications
- For locking the crankshaft during engine repairs, servicing and timing belt replacement

Note: Applications may require additional tools to complete repairs



APPLICATION LIST*

Part No.	Make & Model	Engine	Year
304738	Ford		
	Focus XRS Turbo (LS - LV)	2.5L (B5254T)	2006 - 2012
	Kuga (TE)	2.5L (Duratec)	2012 - 2013
	Mondeo XRS Turbo (MA - MB)	2.5L (B5254T)	2007 - 2014
	Volvo		
	850	2.5L (B5252S)	1993 - 1996
	C30, S70, V70	2.0L - 2.5L (B52, D52)	1997 - 2015
	S40, V40	1.8L - 2.5L (B41, B42, B52)	1997 - 2018
	S60, S60	2.0L - 2.5L (B52, D52)	2000 - 2018
	V50	2.4L, 2.5L (B52, D52)	2004 - 2015
	S80, S80(T)	2.0L - 2.8L (B52, B62 D52)	1998 - 2010
	XC60, XC70, XC90	2.0L - 2.5L (B52, D52)	2000 - 2018

CONTENTS

Tool Ref.	Toledo Tool No.	OEM Tool No.	Description
A	A0645	999 7109	Auxiliary Drive Belt Tensioner Tool
B	A0646	999 5433	Crankshaft Pulley Holding Tool
C	A0647	303-1179	Auxiliary Drive Belt Installer

TOOL REFERENCE

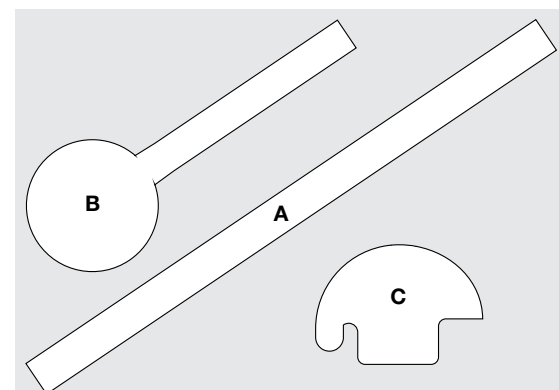

Also suitable: Part No. 304762

TIMING TOOL KIT 

- Suitable for popular Volvo S60 & V60 1.6L petrol engine applications
- **For full kit contents refer to page 150**



UNIVERSAL

DIAL GAUGE TIMING KIT

- Ideal for use in diesel injection pump timing and universal petrol engine applications
- Set includes special purpose adaptors, extensions and dial gauge



Part No.	Description
304772	Dial Gauge Timing Kit

CONTENTS

Tool Ref.	Toledo Tool No.	Description
A	A0409	Dial Gauge
B	A0178	Dial Gauge Adaptors
C	A0052	Extension 100mm
D	A0051	Extension 40mm

TOOL REFERENCE

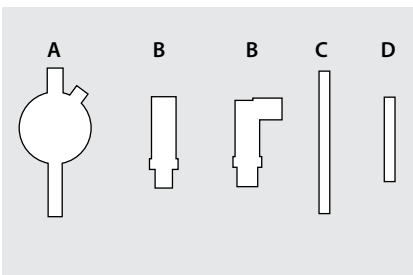

INJECTOR PUMP TIMING KIT

- For use in the removal and installation of timing chains and cylinder heads
- Suitable for use on Bosch EP and VE Rotary, Lucas, CAV Rotodiesel, Peugeot, Nippon Denso, Kikki diesel injector pumps
- Set includes special purpose adaptors, extensions and dial gauge



Part No.	Description
304771	Injector Pump Timing Tool Kit

APPLICATION LIST*

Make	A	B	C	D	E	F	G	H	I	J	Make	A	B	C	D	E	F	G	H	I	J	
Alfa Romeo			•			•	•		•	•	Landrover			•				•	•		•	•
Audi			•	•		•	•		•	•	Mazda			•				•	•		•	•
BMW			•			•	•		•	•	Mitsubishi			•				•	•		•	•
Citroën	•	•			•	•					Nissan			•				•	•		•	•
Daihatsu			•			•	•		•	•	GM			•				•	•			
Fiat			•	•		•	•		•	•	Peugeot	•	•					•	•			
Ford			•	•	•	•	•		•	•	Renault			•	•	•	•	•	•		•	•
Isuzu			•			•	•		•	•	Seat			•				•	•		•	•
Iveco			•			•	•		•	•	VW			•	•			•	•		•	•
Lancia			•			•	•		•	•	Volvo			•				•	•		•	•

CONTENTS

Tool Ref.	Toledo Tool No.	Description
A	A0039	TDC Adaptor Assembly
B	A0051	Extension 40mm
C	A0052	Extension 100mm
D	A0078	M10 Adaptor Short
E	A0079	M8 Adaptor Short
F	A0128	Probe
G	A0140	M8 Adaptor Long
H	A0149	Threaded M8-M12 Adaptor
I	A0407	Mounting Bracket
J	A0409	Dial Gauge

TOOL REFERENCE

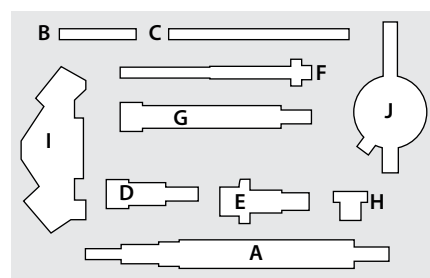

CAMSHAFT LOCKING TOOL

- For the locking of camshaft sprockets and belts during engine servicing and repairs
- Adjustable design featuring belt holders and universal sprocket wedge tools
- Suitable for universal use including SOHC and DOHC cam applications



Part No.	Description
304770	Camshaft locking tool

CONTENTS

Tool Ref.	Toledo Tool No.	Description
A	A0187	Belt Tool
B	A0188	Belt Tool
C	A0242	Timing Belt Clamp
D	A0401	Timing Belt Clamp (Jaws)
E	A0402	Timing Belt Clamp (Jaws)

TOOL REFERENCE

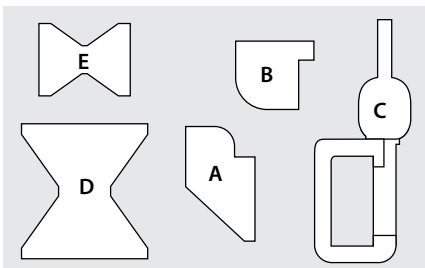

CAMSHAFT HOLDING TOOL

- Designed to hold and manoeuvre the camshaft sprocket on OHC and DOHC engines
- Tool pins locate into the camshaft sprocket spokes to enable sprocket adjustment for accurate alignment and bolt tension
- Assists with camshaft timing belt alignment
- Overall length: 380mm

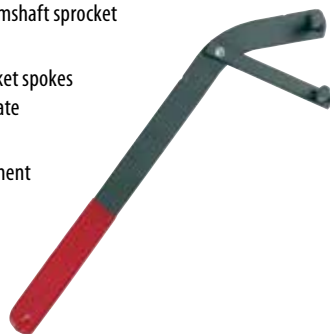

Part No.	Description
304195	Camshaft Holding Tool

CAMSHAFT LOCKING TOOL

- Suitable for locking camshafts during engine servicing and repairs
- Adjustable design for universal vehicle applications



Part No.	Description
304773	Camshaft Locking Tool

TOOL REFERENCE

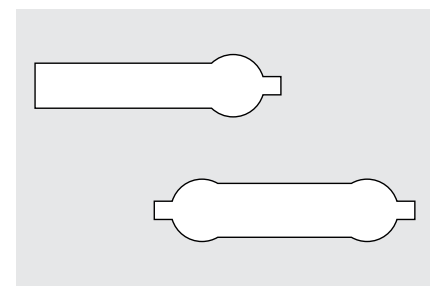

CAMSHAFT HOLDING & LOCKING TOOL

- Fully adjustable locking tool for toothed pulleys with spread ranging from 0mm to 60mm apart
- Ensures camshaft pulleys maintain fixed position during repair or timing belt replacement
- Universal design applicable for a large range of twin cam petrol or diesel engines
- Includes single cam sprocket holding tool
- Supplied in custom moulded plastic hard case



Part No.	Description
304037	Camshaft Holding & Locking Tool

BELT INSTALLATION KIT  

- For use in the installation of flexible multi ribbed drive belts
- Suitable for use on vehicles fitted without automatic drive belt tensioners
- Enables easy damage free stretching of drive belt into the correct position whilst turning the crankshaft pulley by hand
- Contains 3 specially designed installation tools
- Applications include; BMW, Chrysler, Citroën, Ford, Mazda, Peugeot, Volvo

CAUTION Extreme care to be taken during use of this kit. Always refer to the vehicle manufacturer's specifications for correct installation procedures.



Part No.	Description
304775	Belt Installation Kit - Flexible Drive Belt Stretcher

CONTENTS

Tool Ref.	Description
A	Belt Tool
B	Belt Tool
C	Belt Tool
D	Belt Tool
E	Bolts

TOOL REFERENCE

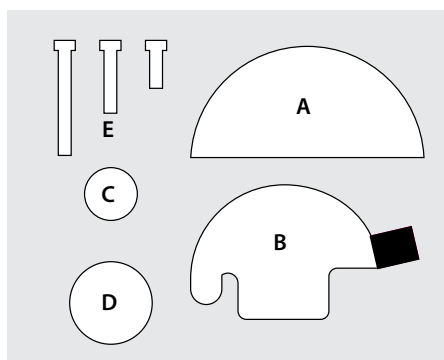

BELT INSTALLATION KIT  

- For use in the installation of flexible multi ribbed drive belts
- Suitable for use on vehicles fitted without automatic drive belt tensioners
- Enables easy damage free stretching of drive belt into the correct position whilst turning the crankshaft pulley by hand
- Contains 2 specially designed installation tools

CAUTION Extreme care to be taken during use of this kit. Always refer to the vehicle manufacturer's specifications for correct installation procedures



Part No.	Description
304776	Belt Installation Kit - Flexible Drive Belt Stretcher

CONTENTS

Tool Ref.	Description
A	Bolts
B	Belt Tool
C	Belt Tool

TOOL REFERENCE

