

# DHC<sup>®</sup>

Model BT2100

**BATTERY & ELECTRICAL SYSTEM ANALYZER**



## OWNER'S MANUAL

**READ ENTIRE MANUAL BEFORE USING THIS PRODUCT**

## TEST PROCEDURES/ OPERATING INSTRUCTIONS

### IMPORTANT:

1. For testing 6 and 12 volt batteries, and 12 and 24 volt charging systems. (ONLY 12 volt for START & STOP battery test)
2. Suggested operation range 32°F(0°C) to 122°F(50°C) in ambient temperature.

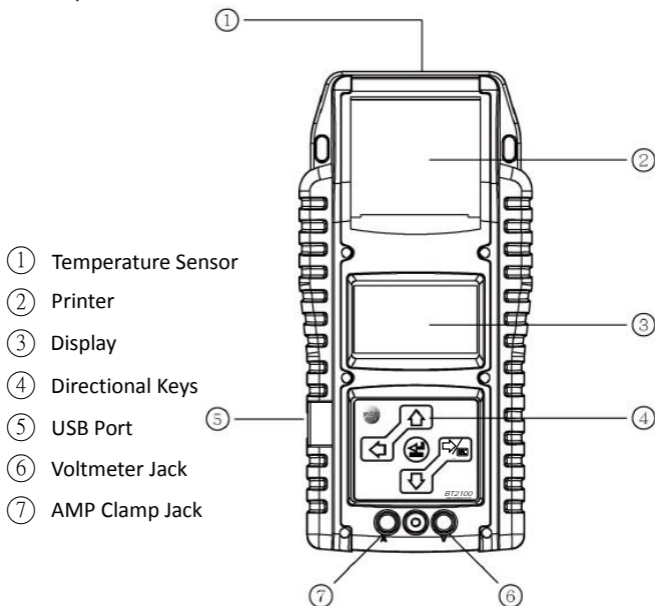

## WARNING:

Pursuant to California Proposition 65, this product contains chemicals known to the State of California to cause cancer and birth defects or other reproductive harm. Wash hands after handling.

1. Working in the vicinity of a lead acid battery is dangerous. Batteries generate explosive gases during normal battery operation. For this reason, it is of utmost importance, if you have any doubt, that each time before using your tester, please read these instructions very carefully.
2. To reduce risk of battery explosion, follow these instructions and those published by the battery manufacturer and manufacturer of any equipment you intend to use in the vicinity of the battery. Observe cautionary markings on these items.
3. Do not expose the tester to rain or snow.

## PERSONAL SAFETY PRECAUTIONS:

1. Someone should be within range of your voice or close enough to come to your aid when you work near a lead acid battery.
2. Have plenty of fresh water and soap nearby in case battery acid contacts skin, clothing or eyes.
3. Wear safety glasses and protective clothing.
4. If battery acid contacts skin or clothing, wash immediately with soap and water. If acid enters eye, immediately flood eye with running cold water for at least ten minutes and get medical attention immediately.
5. NEVER smoke or allow a spark or flame in vicinity of battery or engine.
6. Be extra cautious to reduce risk of dropping a metal tool onto the battery. It could spark or short-circuit the battery or other electrical parts and could cause an explosion.
7. Remove personal metal items such as rings, bracelets, necklaces and watches when working with a lead acid battery. It can produce a short circuit current high enough to weld a ring or the like to metal causing a severe burn.

## PREPARING TO TEST

1. Be sure area around battery is well ventilated while battery is being tested.
2. Clean battery terminals. Be careful to keep corrosion from coming in contact with eyes.
3. Inspect the battery for cracked or broken case or cover. If battery is damaged, do not use tester.
4. If the battery is not sealed maintenance free, add distilled water in each cell until battery acid reaches level specified by the manufacturer. This helps purge excessive gas from cells. Do not overfill.
5. If necessary to remove battery from vehicle to test, always remove ground terminal from battery first. Make sure all accessories in the vehicle are off to ensure you do not cause any arcing.

## BEFORE TEST

1. Before you test a battery in a vehicle, turn off the ignition, all accessories and loads. Close all the vehicle doors and the trunk lid.
2. Make sure you have put 6pcs 1.5V batteries into the battery chamber. Oxyride batteries are not recommended because of the initial 1.7 Volt output. If the 1.5V battery runs out of power, screen will show "REPLACE INTERNAL BATTERY" or "POWER LOW". Replace those 6pcs 1.5V batteries before starting the test.

**Note** that nothing will be seen on the display until the tester is connected to a vehicle battery.

3. Make sure the battery terminals are clean. Wire brush them if necessary. Clamp the black load lead to the vehicle negative battery terminal. Clamp the red load lead to the vehicle positive battery terminal. Please clamp on the lead part of the terminal only. Clamping on the iron part of the terminal will lead to wrong test results.

4. Paper load:

- a. Open the clear cover.
- b. Place a new paper roll in the compartment.
- c. Put a short length of paper from the compartment and press down the clear cover to close.



## START-STOP BATTERY TEST

1. Press the ◀ ▶ key to select START-STOP Test.
2. Press the ◀ ▶ key to select battery type:
  - a. AGM FLAT PLATE
  - b. EFB (ENHANCED FLOODED)Press «ENTER» button to confirm choice.
3. Press the ◀ ▶ key to select battery rating :  
CCA/SAE, EN, IEC, or DIN. Press «ENTER» button to confirm choice.

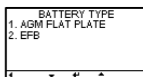

4. Press the ◀ ▶ key to input the battery capacity:

SAE (CCA): 25~3,000

EN: 25~2,830

DIN: 25~1,685

IEC: 25~1,985

Press «ENTER» to begin test.

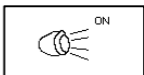
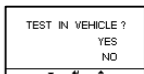
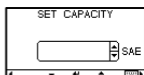

5. Press the ◀ ▶ key to confirm the location of the battery if a surface charge is detected, follow the tester's introductions to remove the surface charge.

6. Aim the "Temperature Measurement sensor" 2.5cm (1 inch) from the top or sides of the battery case and press <<ENETR>>. Measured temperature may vary by distance from the battery, under hood conditions, and cabinet temperature.

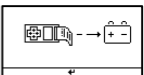

7. Testing battery.



8. Press the ◀ ▶ key to confirm if the battery has been charged recently.

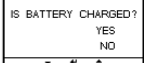

9. When the test is completed, the display shows the results as follows. {Press the ◀ ▶ key to select: Temperature, SOH (STATE OF HEALTH), and SOC (STATE OF CHARGE)}.

**GOOD & PASS**

(GREEN backlight)

The battery is good and capable of holding a charge.

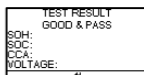

**GOOD & RECHARGE**

(GREEN backlight)

The battery is good but needs to be recharged.

**RECHARGE & RETEST**

(ORANGE backlight)

TEST RESULT GOOD & RECHARGE SOH: SOC: CCA: VOLTAGE: ←
---

Battery is discharged, the battery condition cannot be determined until it is fully charged. Recharge & retest the battery.

TEST RESULT RECHARGE & RETEST SOH: SOC: CCA: VOLTAGE: ←
---

**BAD & REPLACE**

(RED backlight)

The battery will not hold a charge. It should be replaced immediately.

TEST RESULT BAD & REPLACE SOH: SOC: CCA: VOLTAGE: ←
---

**BAD CELL & REPLACE**

(RED backlight)

The battery has at least one cell short circuit. It should be replaced immediately.

TEST RESULT BAD CELL REPLACE SOH: SOC: CCA: VOLTAGE: ←
--

10. Add RO# and VIN#? YES or NO. Select YES to enter RO number and vehicle plate number.

RO/VIN NUMBER ----- 0 1 2 3 4 ABC 5 6 7 8 9 ← OK
--

LICENSE PLATE NUMBER ----- 0 1 2 3 4 ABC 5 6 7 8 9 ← OK
---

11. Press ENTER to print the result.

PRINT RESULT ? YES NO ←
----------------------------------



**NOTE:** Under certain conditions the follow messages may be displayed.

**LOAD ERROR**

LOAD ERROR ←
-----------------

The tested battery is bigger than 3000 SAE (CCA) or the connection is not established. Check the capacity of the battery & make sure the clamps are properly connected.

## CHECK CLAMP

The connection between battery and cable set is loosed, please check cable clamp.



## INTERNAL BATTERY LOW

Please change new AA batteries.

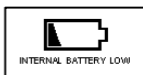

## NO PAPER

Please insert new paper row.



## VOLTAGE HIGH

The voltage of tested battery is too high and cannot be measured.

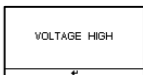

## VOLTAGE UNSTABLE

The voltage of tested battery is unstable Please switch off the engine, wait for 90 second and retest.

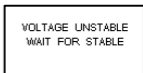



## BATTERY TEST

- Press the ◀ ▶ key to select Battery Test.
- Press the ◀ ▶ key to confirm the battery voltage.
- Press the ◀ ▶ key to confirm if the battery has been charged recently.
- Press the ◀ ▶ key to select the battery type:
  - FLOODED
  - AGM FLAT PLATE
  - AGM SPIRAL
  - VRLA/GEL
 Press «ENTER» to confirm choice.
- Press the ◀ ▶ key to select battery rating :  
CCA/SAE, EN, IEC or DIN. Press «ENTER» to confirm choice.
- Press the ◀ ▶ key to input the battery capacity :
  - SAE (CCA) : 25~3,000
  - EN : 25~2,830
  - DIN : 25~1,685
  - IEC : 25~1,985
  - JIS : Battery Type No.
 Press «ENTER» to begin the test.
- Press the ◀ ▶ key to confirm the location of the battery if a surface charge is detected, follow the tester 's instruction to remove the surface charge.
- Testing battery.

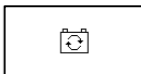
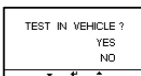
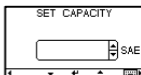
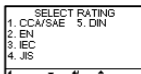
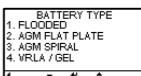
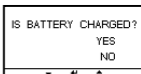
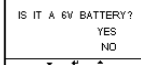
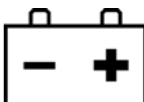

9. Aim the "Temperature Measurement sensor" 2.5cm (1 inch) from the top or sides of the battery case and press <<ENETR>>. Measured temperature may vary by distance from the battery, under hood conditions, and cabinet temperature.

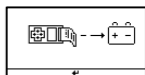

10. When the test is completed, the display shows the results as following. {Press the ◀ ▶ key to select: Temperature, SOH (STATE OF HEALTH), and SOC (STATE OF CHARGE)}.

## GOOD & PASS

The battery is good and capable of holding a charge.

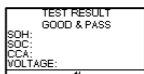

## GOOD & RECHARGE

The battery is good but needs to be recharged.

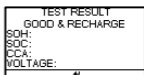

## RECHARGE & RETEST

Battery is discharged, the battery condition cannot be determined until it is fully charged. Recharge & retest the battery.

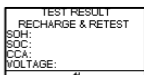

## BAD & REPLACE

The battery will not hold a charge. It should be replaced immediately.

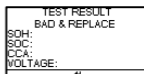

## BAD CELL & REPLACE

The battery has at least one cell short circuit. It should be replaced immediately.

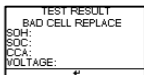

11. Press ENTER button to enter RO number and vehicle plate number.

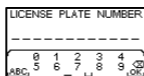
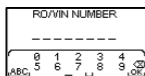

12. Press ENTER to print the result.

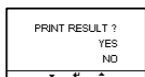

**NOTE:** Under certain conditions the follow messages may be displayed.

## LOAD ERROR

The tested battery is bigger than 3000 SAE (CCA) or the connection is not established. Check the capacity of the battery & make sure the clamps are properly connected.



## CHECK CLAMP

The connection between battery and cable set is loosed, please check cable clamp.

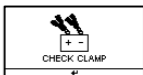

## INTERNAL BATTERY LOW

Please change new AA batteries.



## NO PAPER

Please insert new paper row.



## VOLTAGE HIGH

The voltage of tested battery is too high and cannot be measured.

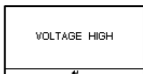

## VOLTAGE UNSTABLE

The voltage of tested battery is unstable Please switch off the engine, wait for 90 second and retest.

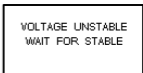

## SYSTEM TEST



1. Press the ◀ ▶ key to select Battery Test.
2. Turn off all vehicle accessory loads such as light, air conditioning, radio, etc. before starting the engine.

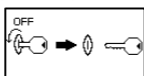
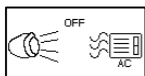

3. When the engine is started, one of the three results will be displayed along with the actual measured result.

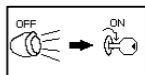

### CRANKING VOLTS NORMAL

The system is showing normal draw. Press «ENTER» to perform the charging system test.

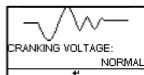

### CRANKING VOLTS LOW

The cranking voltage is below normal limits, troubleshoot the starter with manufacturers recommended procedure.

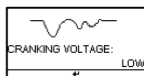

### CRANKING VOLTS NO DETECTED

The cranking voltage is not detected.

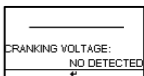

- If the cranking voltage is normal, press «ENTER» to begin charging system test.
- Press the «ENTER» key, you will view the following screen.
- Press the «ENTER» key, one of the three results will be displayed along with the actual reading measured.



**NOTE:** Under certain conditions the follow messages may be displayed.

## LOW CHARGING VOLTS WHEN TEST AT IDLE

The alternator is not providing sufficient current to the battery. Check the belts to ensure the alternator is rotating with engine running. If the belts are slipping or broken, replace the belts and retest.

Check the connections from the alternator to the battery. If the connection is loose or heavily corroded, clean or replace the cable and retest. If the belts and connections are in good condition, replace the alternator.

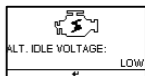

## CHARGING SYSTEM NORMAL WHEN TEST AT IDLE

The system is showing normal output from the alternator, no problem is detected.

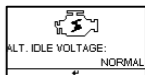

## HIGH CHARGING VOLTS WHEN TEST AT IDLE

The voltage output from the alternator to the battery exceeds the normal limits of a functioning regulator. Check to ensure there is no loose connection and the ground connection is normal. If there is no connection issue, replace the regulator. Since most alternators have the regulator built-in, this will require you to replace the alternator. The normal high limit of a typical

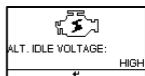

automotive regulator is 14.7 volts +/- 0.05. Check manufacturer specifications for the correct limit, as it will vary by vehicle type and manufacturer.

7. Following the charging system at idle, press «ENTER» for the charging system with accessory loads. Turn on the heater blower to high, high beam headlights, and rear defogger (If equipped). Do not use cyclical loads such as air conditioning or windshield wipers.

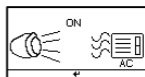

8. When testing older model diesel engines, the user need to run up the engine to 2500 rpm for 15 seconds. You will see the run engine up instruction screen.



9. Press «ENTER» to look for the amount of ripple from the charging system to the battery. One of two testing results will be displayed along with the actual testing measured.

## RIPPLE DETECTED NORMAL

Diodes function well in the alternator / stator.

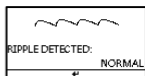

OR

## EXCESS RIPPLE

One or more diodes in the alternator are not functioning or there is stator damage. Check to ensure the alternator mounting is affixed securely and that the belts are in good shape and functioning properly. If the mounting and belts are good, replace the alternator.

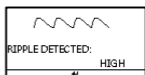
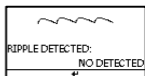

10. Press the «ENTER» key to continue the charging system with accessory loads. One of the three results will be displayed along with the actual testing measured.

## CHARGING SYSTEM **LOW** WHEN TEST WITH ACC. LOADS

The alternator is not providing sufficient current for the system's electrical loads and the charging current for the battery. Check the belts to ensure the alternator is rotating with the engine running.

If the belts are slipping or broken, replace the belts and retest. Check the connections from the alternator to the battery. If the connection is loose or heavily corroded, clean or replace the cable and retest. If the belts and connections are in good working condition, replace the alternator.

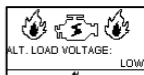

## CHARGING SYSTEM **NORMAL** WHEN TEST WITH ACC. LOADS

The system is showing normal output from the alternator, no problem detected.

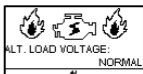

## CHARGING SYSTEM **HIGH** WHEN TEST WITH ACC. LOADS

The voltage output from the alternator to the battery exceeds the normal limits of a functioning regulator. Check to ensure there are no loose connections and that the ground connection is connected properly. If there are no connection issues, replace the regulator. Since most alternators have the regulator built-in, this will require you to replace the alternator.



11. When the test is completed, the display shows the results as following.

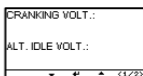

12. Press ENTER to print the result.

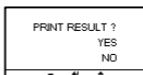

## IR TEST

1. Press the ◀ ▶ key to select IR TEST.
2. Press the ◀ ▶ key to confirm the battery voltage.
3. Press the ◀ ▶ key to confirm if the battery has been charged recently.
4. If the battery has NOT been charged, please select "NO" to recharge and retest the battery. If the battery has been charged, please select "YES" and proceed the test.

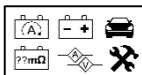
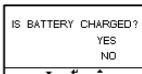
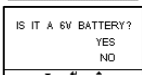
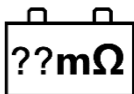

5. Aim the "Temperature Measurement sensor" 2.5cm (1 inch) from the top or sides of the battery case and press <<ENETR>>. Measured temperature may vary by distance from the battery, under hood conditions, and cabinet temperature.

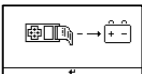

6. Testing battery.



7. When the test is completed, the display shows the results as following.

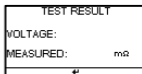

8. Press ENTER to print the result.

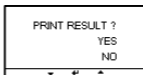



## VM/AM TEST

### AM TEST

1. Install the 9V battery.
2. Connect Clamp Meter to the jack A on BT2100. Press POWER.
3. Press the button ZERO. Make sure the display reads zero.
4. Press the trigger to open the transformer jaws and clamp one electrical wire.
5. Make sure the clamp jaw is perfectly closed.
6. Read the displayed value.

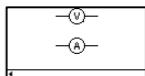
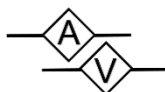

### VM TEST

1. Connect Red Test Lead to the jack V on BT2100.
2. Use the test lead to touch a point within the network of the battery.
3. Read the displayed value.

NOTE: Do not test the volt more than 60V. It may damage the tester.

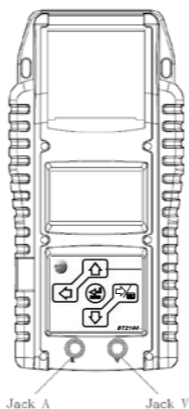
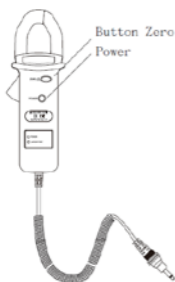

## SETTING AND INFORMATION RETRIEVAL

Press the ◀ ▶ key to select Setting.

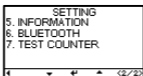
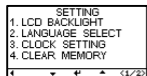

### LCD BACKLIGHT

1. Press the directional keys to get to the LCD BACKLIGHT.
2. Press the directional keys to adjust the brightness of the display.
3. Press ENTER and the display returns to the menu.

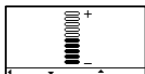

### LANGUAGE SELECT

1. Press the directional keys to get to the LANGUAGE SELECT display.
2. Press ENTER and the display will show the language options. Press the directional keys to select the language you want the tester to display.
3. Press ENTER and the display returns to the menu.

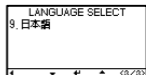
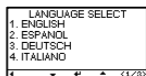

### CLOCK SETTING

1. Press the directional keys to get to the CURRENT DATE/TIME display.
2. Press ENTER and use virtual keyboard to adjust YEAR/MONTH/DAY/HOUR/MINUTE/SECOND and change the setting.
3. Press ENTER and the display returns to the menu.

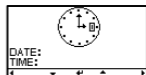

### CLEAR MEMORY

1. Press the directional keys to get to the CLEAR MEMORY.
2. Select "YES" to delete the memory.
3. Press «ENTER» button and the display returns to the menu.

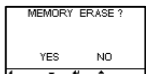

## INFORMATION

1. Press the directional keys to enter INFORMATION.
2. Use the direction key to input customized data.
3. Press «ENTER» button and the display returns to the menu.



## BLUETOOTH

1. Press the directional keys to enter BLUETOOTH.
2. Press ENTER and the display will show the connection status.
3. Log in APP and use it to connect tester.



## TEST COUNTER

1. Press the directional keys to enter TEST COUNTER.

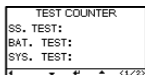

2. Press  to find PRINT and print the test counter record.

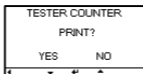
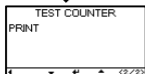

3. Press ENTER to erase specific test counter records.

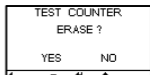

## PC NAVIGATION GUIDE

Each BT2100 comes with a CD, including the driver of the software installation DHC SYNC and its user guide.

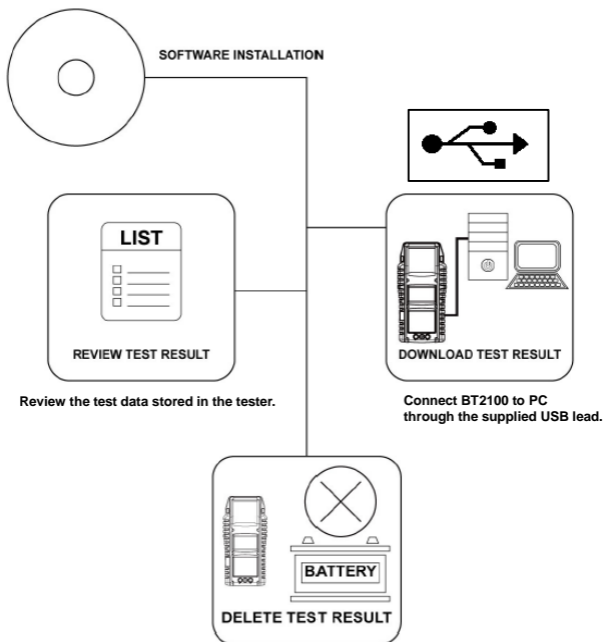

# DHC®

Modèle BT2100

ANALYSEUR DE SYSTÈME DE BATTERIE & ELECTRIQUE



## MANUEL DE L'UTILISATEUR

LIRE L'ENSEMBLE DU MANUEL AVANT D'UTILISER CE PRODUIT

## PROCEDURES DE TEST/INSTRUCTIONS D'OPERATIONS IMPORTANT:

1. Pour tester des batteries de 6 et 12 volts, et des systèmes de charge de 12 et 24 volts. (SEULEMENT 12 volt pour le test de batterie START & STOP)
2. Fourchette d'utilisation suggérée 32°F (0°C) à 122°F (50°C) à température ambiante.

① Capteur de température

② Imprimante

③ Ecran

④ Touches de direction

⑤ Port USB

⑥ Jack Tensiomètre

⑦ Jack Ecrou AMP

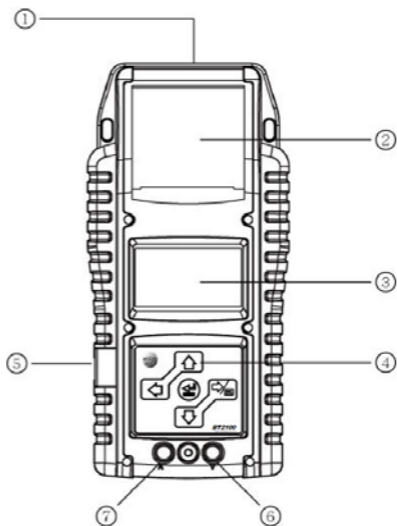

## **AVERTISSEMENT:**

Conformément à la Proposition Californienne 65, ce produit contient des éléments chimiques connus de l'Etat de Californie pour causer des cancer et défauts de naissance ou autres anomalies congénitales. Se laver les mains après manipulations.

1. Travailler à proximité de batterie au plomb est dangereux. Les batteries génèrent des gaz explosifs pendant leur fonctionnement normal. Pour cette raison, il est primordial, en cas de doute, qu'avant chaque utilisation du testeur vous lisiez ces instructions avec attention.
2. Pour réduire le risque d'explosion de batterie, suivez ces instructions et celles publiées par le fabricant de pile et le fabricant de tout équipement que vous envisagez d'utiliser à proximité d'une batterie. Observez les marques de précaution sur ces éléments.
3. Ne pas exposer le testeur à la pluie ou la neige.

## **PRECAUTIONS PERSONNELLES DE SECURITÉ:**

1. Quelqu'un devrait rester à portée de votre voix ou assez prêt pour vous venir en aide lorsque vous travaillez près d'une batterie au plomb.
2. Disposer de beaucoup d'eau fraîche et de savon à portée au cas où l'acide de la batterie entre en contact avec la peau, les vêtements ou les yeux.
3. Porter des lunettes de sécurité et vêtements de protection.
4. Si l'acide de la batterie entre en contact avec la peau, les vêtements ou les yeux, lavez immédiatement à l'eau et au savon. Si l'acide entre en contact avec l'oeil, inonder immédiatement l'oeil à l'aide d'eau froide pendant au moins dix minutes et obtenez une assistance médicale immédiatement.
5. Ne fumez ou ne laissez JAMAIS une étincelle ou flamme à proximité de batterie ou moteur.
6. Soyez plus que prudent afin de réduire le risque de laisser un outil métallique sur la batterie. Cela pourrait allumer ou court-circuiter la batterie ou d'autres composants électriques, et pourrait entraîner une explosion.
7. Retirer les objets métalliques personnels comme les bagues, colliers et montres lorsque vous travaillez avec une batterie au plomb. Cela peut provoquer un court circuit électrique suffisamment puissant pour souder un anneau ou objet métallique causant une brûlure sévère.

## PREPARATION AU TEST

1. Assurez-vous que la zone autour de la batterie soit bien ventilée lorsque la batterie est testée.
2. Nettoyez les bornes de la batterie. prêtez attention à empêcher la corrosion d'entrer en contact avec les yeux.
3. Inspectez la batterie pour un boîtier ou couvercle craquelé ou cassé. Si la batterie est endommagée, n'utilisez pas le testeur.
4. Si la batterie n'est pas garantie zéro maintenance, ajouter de l'eau distillée dans chaque cellule jusqu'à ce que l'acide de la batterie atteigne un niveau spécifié par le fabricant. Cela aide à purger toute excès de gaz des cellules. Ne pas faire déborder.
5. S'il est nécessaire de retirer la batterie du véhicule pour tester, retirer toujours en premier la borne de terre de la batterie. Assurez-vous que tous les accessoires dans le véhicule soient éteints pour éviter de faire un arc.

## AVANT DE TESTER

1. Avant de tester une batterie dans le véhicule, éteignez le contact, tous les accessoires et charges. Fermez toutes les portes du véhicule ainsi que le coffre.
2. Assurez-vous de disposer de 6x piles de 1,5V dans le compartiment de batteries. Les piles oxyride ne sont pas recommandées à cause de la sortie 1,7 Volt initiale. Si la pile de 1,5V n'a plus de tension, l'écran affichera "REEMPLACER LA BATTERIE" ou "TENSION BASSE". Remplacer ces 6x piles de 1,5V avant de démarrer le test.

**Remarque:** rien ne sera visible à l'écran jusqu'à ce que le testeur soit connecté à une pile du véhicule.

3. Assurez-vous que les bornes de batterie soient propres. Nettoyez-la à l'aide d'une brosse en laiton si nécessaire. Serrez le câble noir du testeur au terminal de batterie négative du véhicule. Serrez le câble rouge du testeur au terminal de batterie positive du véhicule. Veillez à serrer seulement le composant en plomb du terminal. Serrer le composant en fer du terminal entraînerait des résultats de test erronés.



## 4. Charge de papier:

- a. Ouvrir la couverture transparente.
- b. Placez un nouveau rouleau de papier dans le compartiment.
- c. Placez une petite longueur de papier du compartiment et appuyez sur le couvercle transparent pour fermer.



## TEST DE BATTERIE START-STOP

1. Appuyer sur les touches ◀ ▶ pour sélectionner le Test START-STOP.
2. Appuyez sur les touches ◀ ▶ pour sélectionner le type de batterie:
  - a. AGM PLAQUE PLATE
  - b. EFBAppuyez sur la touche "ENTRER" pour confirmer le choix.
3. Appuyez sur la touche ◀ ▶ pour sélectionner la notation de la batterie: CCA/SAE, EN, IEC, ou DIN. Appuyez sur la touche "ENTRER" pour confirmer le choix.

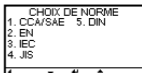
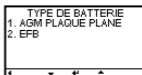

4. Appuyez sur la touche ◀ ▶ pour entrer la capacité de la batterie:

SAE (CCA): 25 ~ 3,000

EN: 25 ~ 2,830

DIN: 25 ~ 1,685

IEC: 25 ~ 1,985

Appuyez sur "ENTRER" pour commencer le test.

5. Appuyez sur la touché ◀ ▶ pour confirmer la localisation de la batterie si la charge de la surface est détectée, suivez les introductions du testeur pour retirer la charge de la surface.

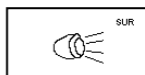
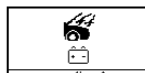
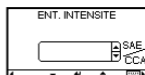

6. Viser les 2,5cm (1 pouce) du "capteur de mesure de temperature" à partir du dessus ou des côtés de la batterie et appuyez sur "ENTRER". La température mesurée peut varier en fonction de la distance à partir de la batterie, des conditions sous le capot, et la température du compartiment.

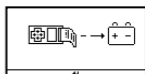

7. Test de la batterie.

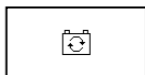

8. Appuyez sur la touche ◀ ▶ pour confirmer si la batterie a récemment chargée.

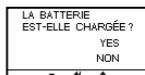

9. Lorsque le test est terminé, l'écran montre les résultats comme suit. (Appuyez sur la touche ◀ ▶ pour sélectionner: Température, SOH (ETAT DE SANTE), et SOC (ETAT DE CHARGE)).

## BON & PASS

(Rétro-éclairage VERT)

La batterie est bonne et capable de tenir une charge.

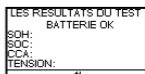

## BONNE & RECHARGE

(Rétro-éclairage VERT)

La batterie est bonne mais doit être rechargée.

LES RESULTATS DU TEST	
OK A RECHARGER	
SOH:	
SOC:	
CCA:	
TENSION:	

## RECHARGE & NOUVEAU TEST

(Rétro-éclairage ORANGE)

La batterie est déchargée, la condition de la pile ne peut pas être déterminée jusqu'à sa pleine charge. Rechargez & testez à nouveau la pile.

LES RESULTATS DU TEST	
CHARGER & TESTER	
SOH:	
SOC:	
CCA:	
TENSION:	

## MAUVAISE & REMPLACEMENT

(Rétro-éclairage ROUGE)

La batterie ne tiendra pas la charge. Elle devrait être remplacée immédiatement.

LES RESULTATS DU TEST	
A REMPLACER	
SOH:	
SOC:	
CCA:	
TENSION:	

## MAUVAISE CELLULE & REMPLACEMENT

(Rétro-éclairage ROUGE)

La batterie a au moins une cellule en court circuit. Elle doit être remplacée immédiatement.

LES RESULTATS DU TEST	
CEL DEF. A REMPL	
SOH:	
SOC:	
CCA:	
TENSION:	

1. Ajoutez RO# et VIN#? YES ou NON. Sélectionnez YES pour entrer le numéro RO et le numéro d'immatriculation du véhicule.

RO/VIN NUMÉRO				
-----				
0	1	2	3	4
5	6	7	8	9
ABC				OK

NUMERO PLAQUE IMM				
-----				
0	1	2	3	4
5	6	7	8	9
ABC				OK

2. Appuyez sur ENTER pour imprimer le résultat.

IMPRIMER TEST ?	
YES	
NON	



**REMARQUE:** Sous certaines conditions, les messages suivants peuvent être visualisés.

## ERREUR DE CHARGEMENT

La batterie testée est plus grosse que 3000 SAE (CCA) ou la connexion n'est pas établie. Vérifiez la capacité de la batterie & assurez-vous que les pinces soient correctement connectées.

ERREUR CHARGE

## VERIFIER LES PINCES

La connexion entre la batterie et le câble est lâche, veuillez vérifier la pince du câble.



## BATTERIE INTERNE FAIBLE

Veuillez changer par de nouvelles piles AA.



## PLUS DE PAPIER

Veuillez insérer une nouvelle rame de papier.



## TENSION HAUTE

La tension de la batterie testée est trop forte et ne peut pas être mesurée.

TENSION HAUTE

## TENSION INSTABLE

La tension de la batterie testée est instable. Veuillez éteindre le moteur, attendez 90 secondes et testez à nouveau.

TENSION INSTABLE  
ATTENDRE STABLE

## TEST DE BATTERIE

- Appuyez sur touches ◀ ▶ pour sélectionner le Test de Batterie
- Appuyez sur touches ◀ ▶ pour confirmer la tension de la batterie.
- Appuyez sur la touche ◀ ▶ pour confirmer si la batterie a récemment chargée.
- Appuyez sur touches ◀ ▶ pour sélectionner le type de batterie:
  - LIQUIDE STANDARD
  - AGM PLAQUE PLATE
  - AGM SPIRAL
  - VRLA/GEL
 Press "ENTER" to confirm choice.
- Appuyez sur la touche ◀ ▶ pour sélectionner la notation de la batterie: CCA/SAE, EN, IEC, ou DIN. Appuyez sur "ENTRER" pour confirmer le choix.
- Appuyez sur la touche ◀ ▶ pour entrer la capacité de la batterie:
  - SAE (CCA): 25 ~ 3,000
  - EN: 25~2,830
  - DIN: 25~1,685
  - IEC: 25~1,985
  - JIS: Battery Type No.
 Appuyez sur "ENTRER" pour commencer le test.
- Appuyez sur la touche ◀ ▶ pour confirmer la localisation de la batterie si la charge de la surface est détectée, suivez les introductions du testeur pour retirer la charge de la surface.
- Viser les 2,5cm (1 pouce) du "capteur de mesure de température" à partir du dessus ou des côtés de la batterie et appuyez sur "ENTRER". La température mesurée peut varier en fonction de la distance à partir de la batterie, des conditions sous le capot, et la

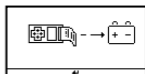
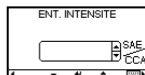
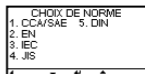
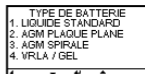
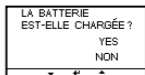
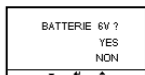
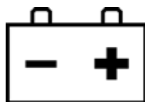

température du compartiment.

9. Test de la batterie.

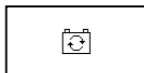

10. Lorsque le test est finalisé, l'écran affiche les résultats comme suit. {Appuyez sur la touche ◀ ▶ pour sélectionner: Température, SOH (ETAT DE SANTE), et SOC (ETAT DE CHARGE)}.

## BON & PASS

La batterie est bonne et capable de tenir une charge.

LES RESULTATS DU TEST BATTERIE OK SOH: SOC: CCA: TENSION:
--

## BONNE & RECHARGE

La batterie est bonne mais doit être rechargée.

LES RESULTATS DU TEST OK A RECHARGER SOH: SOC: CCA: TENSION:
---

## RECHARGE & NOUVEAU TEST

La batterie est déchargée, la condition de la pile ne peut pas être déterminée jusqu'à sa pleine charge. Rechargez & testez à nouveau la pile.

LES RESULTATS DU TEST CHARGER & TESTER SOH: SOC: CCA: TENSION:
---

## MAUVAISE & REMPLACEMENT

La batterie ne tiendra pas la charge. Elle devrait être remplacée immédiatement.

LES RESULTATS DU TEST A REMPLACER SOH: SOC: CCA: TENSION:
--

## MAUVAISE CELLULE & REMPLACEMENT

La batterie a au moins une cellule en court circuit. Elle doit être remplacée immédiatement.

LES RESULTATS DU TEST CEL DEF. A REMPL SOH: SOC: CCA: TENSION:
---

1. Appuyez sur le bouton ENTRER pour entrer le numéro RO et le numéro d'immatriculation du véhicule.

RO/VIN NUMÉRO
----
0 1 2 3 4
5 6 7 8 9
ABC, OK

NUMERO PLAQUE IMM
----
0 1 2 3 4
5 6 7 8 9
ABC, OK

2. Appuyez sur ENTER pour imprimer le résultat.

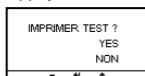

**REMARQUE:** Sous certaines conditions, les messages suivants peuvent être visualisés.

## ERREUR DE CHARGEMENT

La batterie testée est plus grosse que 3000 SAE (CCA) ou la connexion n'est pas établie. Vérifiez la capacité de la batterie & assurez-vous que les pinces soient correctement connectées.

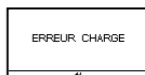

## VERIFIER LES PINCES

La connexion entre la batterie et le câble est lâche, veuillez vérifier la pince du câble.

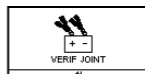

## BATTERIE INTERNE FAIBLE

Veuillez changer par de nouvelles piles AA.



## PLUS DE PAPIER

Veuillez insérer une nouvelle rame de papier.



## TENSION HAUTE

La tension de la batterie testée est trop forte et ne peut pas être mesurée.





## TENSION INSTABLE

La tension de la batterie testée est instable. Veuillez éteindre le moteur, attendez 90 secondes et testez à nouveau.

TENSION INSTABLE  
ATTENDRE STABLE

## TEST DU SYSTEME

1. Appuyez sur touches ◀ ▶ pour sélectionner le Test de Batterie.



2. Eteignez tous les postes de charge des accessoires du véhicule comme la lumière, la climatisation, la radio, etc. avant de démarrer le moteur.

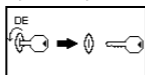
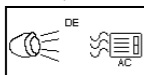

3. Quand le moteur a démarré, l'un des trois résultats sera visualisé avec le résultat réel mesuré.

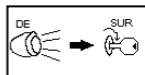

## TENSION MANIVELLE NORMALE

Le système affiche un dessin normal. Appuyez sur "ENTRER" pour procéder au test du système de recharge.

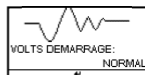

## TENSION MANIVELLE BASSE

La tension de la manivelle est inférieure aux limites normales, réparer le starter à l'aide de la procédure recommandée par les fabricants.

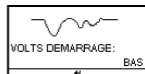

## TENSION DE MANIVELLE NON DÉTECTÉE

La tension de la manivelle n'est pas détectée.

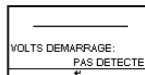

1. Si la tension de la manivelle est normale, appuyez sur "ENTRER" pour démarrer le test du système de recharge.

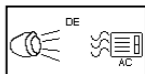

2. Appuyez sur la touche "ENTRER", vous visualiserez l'écran suivant.
3. Appuyez sur la touche "ENTRER", l'un des trois résultats sera visualisé avec la lecture de la mesure réelle.

**REMARQUE:** Sous certaines conditions, les messages suivants peuvent être visualisés.

## TENSION DE CHARGE BASSE LORS DU TEST AU RALENTI

L'alternateur ne fournit pas suffisamment de tension à la pile. Vérifiez les courroies pour vous assurer que l'alternateur tourne quand le moteur est en marche. Si les courroies patinent ou sont cassées, remplacez-les et testez à nouveau. Vérifiez les connexions entre l'alternateur et la batterie. Si la connexion est lâche ou fortement corrodée, nettoyez ou remplacez le câble et testez à nouveau. Si les courroies et les connexions sont en bonne condition, remplacez l'alternateur.



## CHARGE DU SYTEME NORMALE LORS DU TEST AU RALENTI

Le système montre un fonctionnement normal de l'alternateur, aucun problème n'est détecté.



## TENSION DE CHARGE HAUTE LORS DU TEST AU RALENTI

La sortie de tension de l'alternateur vers la batterie dépasse les limites normales d'un régulateur en fonction. Assurez-vous qu'il n'y a pas de perte de connexion et que la prise de terre est normale. S'il n'y a pas de problème de connexion, remplacez le régulateur. Etant donné que la plupart des alternateurs disposent d'un régulateur intégré. La limite supérieure normale d'un régulateur automobile standard est 14.7 volts +/- 0.05. Vérifiez les spécifications du fabricant pour la limite correcte, car elle va varier en fonction du type de véhicule et du fabricant.



1. Après avoir testé le système de charge à vide, appuyez sur "ENTRER" pour le tester avec les accessoires. Placez le ventilateur en position haute, phares avant à haute intensité, et un désembueur arrière (si présent). Ne pas utiliser de charges cycliques comme la climatisation ou les essuie-glaces.
2. Pour le test des moteurs diesel ancien modèle, il faut faire tourner le moteur jusqu'à 2500rpm pendant 15 secondes. Vous verrez l'écran d'instructions apparaitre.
3. Appuyez sur "ENTRER" pour obtenir le taux d'ondulation du système de charge vers la batterie. Un des deux résultats de test s'affichera avec la mesure de test réelle.

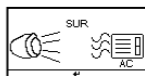

## ONDULATION DÉTECTÉE NORMALE

Les diodes fonctionnent correctement dans l'alternateur/stator.



OU



## ONDULATION EXCESSIVE DÉTECTÉE

Une diode ou plus dans l'alternateur ne fonctionnent pas ou bien le stator est endommagé. Assurez-vous que le support de l'alternateur est fixé correctement et que les courroies soient en bonne condition et fonctionnent correctement. Si le support et les courroies sont bonnes, remplacez l'alternateur.



1. Appuyez sur la touche "ENTRER" pour continuer la recharge des accessoires du système. L'un des trois résultats sera visualisé avec les tests de mesure réelle.

## CHARGE DU SYSTEME BASSE LORS DU TEST AVEC CHARGES D'ACC.

L'alternateur ne fournit pas de tension suffisante pour assurer la charge électrique du système et la tension de charge de la batterie. Vérifiez les courroies pour vous assurer que l'alternateur tourne quand le moteur est en marche. Si les courroies patinent ou sont cassées, remplacez-les et testez à nouveau. Vérifiez les connexions entre l'alternateur et la batterie. Si la connexion est lâche ou fortement corrodée, nettoyez ou remplacez le câble et testez à nouveau. Si les courroies et les connexions ne sont pas en bonne condition, remplacez l'alternateur.



## CHARGE DU SYSTEME NORMALE LORS DU TEST AVEC CHARGES D'ACC.

Le système montre une sortie normale de l'alternateur, aucun problème détecté.



## CHARGE DU SYSTEME HAUTE LORS DU TEST AVEC CHARGES D'ACC.

La sortie de tension de l'alternateur vers la batterie dépasse les limites normales d'un régulateur en fonction. Assurez-vous qu'il n'y ait pas de pertes de connexion et que la prise de terre est bien connectée. S'il n'y a pas de problème de connexion, remplacez le régulateur. Etant donné que la plupart des alternateurs disposent d'un régulateur intégré.

1. Lorsque le test est finalisé, l'écran affiche les résultats comme suit.

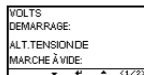
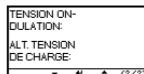

2. Appuyez sur ENTER pour imprimer le résultat.

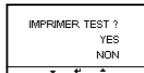

## TEST IR

1. Appuyez sur la touche ◀ ▶ pour sélectionner IR TEST.
2. Appuyez sur touches ◀ ▶ pour confirmer la tension de la batterie.
3. Appuyez sur la touche ◀ ▶ pour confirmer si la batterie a récemment chargée.
4. Si la batterie n'a PAS été chargée, veuillez sélectionner "NO" pour recharger et tester à nouveau la batterie. Si la batterie a été chargée, veuillez sélectionner "YES" et procéder au test.
5. Viser les 2,5cm (1 pouce) du "capteur de mesure de température" à partir du dessus ou des côtés de la batterie et appuyez sur "ENTRER". La température mesurée peut varier en fonction de la distance à partir de la batterie, des conditions sous le capot, et la température du compartiment.
6. Test de la batterie.
7. Lorsque le test est finalisé, l'écran affiche les résultats comme suit.
8. Appuyez sur ENTER pour imprimer le résultat.

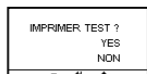
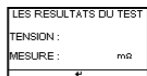
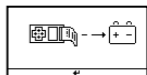
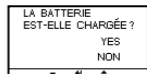
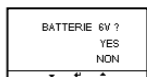
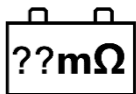

## TEST VM/AM

### TEST AM

1. Installer la batterie 9V.
2. Connecter la Pince Ampèremétrique à la jack A sur le BT2100. Appuyer sur POWER.
3. Appuyer sur le bouton ZERO. Assurez-vous que l'écran visualise zero.
4. Appuyer sur le déclencheur pour ouvrir les mâchoires du transformateur et serrer un câble électrique.
5. Assurez-vous que la mâchoire du serre-joint soit parfaitement fermée.
6. Lire la valeur affichée.

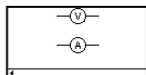

### TEST VM

1. Connecter le Câble Test Rouge à la prise jack V sur BT2100.
2. Utiliser le câble test pour toucher un point sur le réseau de la batterie.
3. Lire la valeur affichée.

**REMARQUE:** Ne pas tester une tension supérieure à 60V. Cela pourrait endommager le testeur.

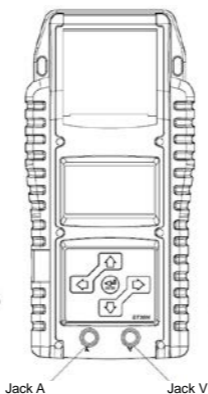
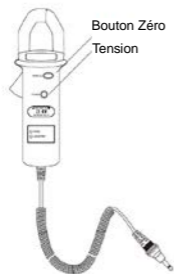

## CONFIGURATION ET RECUPERATION D'INFORMATIONS

Appuyer sur la touche ◀ ▶ pour sélectionner la Configuration.

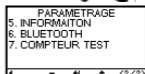
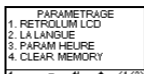

### RETROECLAIRAGE LCD

1. Appuyez sur les touches de direction pour accéder au RETROECLAIRAGE LCD.
2. Appuyez sur les touches de direction pour ajuster la luminosité de l'écran.
3. Appuyez sur ENTRER et l'écran retourne au menu.

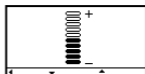

### SELECTION DE LA LANGUE

1. Appuyez sur les touches de direction pour accéder à l'écran SELECTION LANGUE.
2. Appuyez sur ENTRER et l'écran affiche les options de langue. Appuyez sur les touches de direction pour sélectionner la langue choisie.
3. Appuyez sur ENTRER et l'écran retourne au menu.

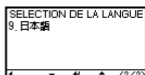
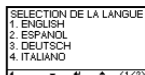

### CONFIGURATION DE L'HEURE

1. Appuyez sur les touches de direction pour accéder à l'écran DATE/HEURE ACTUELLE.
2. Appuyez sur ENTRER et utilisez le clavier virtuel pour ajuster ANNÉE/MOIS/JOUR/HEURE/MINUTE/SECONDE et changez la configuration.
3. Appuyez sur ENTRER et l'écran retourne au menu.



### EFFACER LA MEMOIRE

1. Appuyez sur les touches de direction pour accéder à EFFACER LA MEMOIRE.
2. Sélectionner "YES" pour effacer la mémoire.
3. Appuyez sur le bouton "ENTRER" et l'écran retourne au menu.

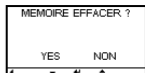

## INFORMATION

1. Appuyez sur touches de direction pour entrer l'INFORMATION.
2. Utilisez la touche de direction pour entrer les données personnalisées.
3. Appuyez sur le bouton "ENTRER" et l'écran retourne au menu.

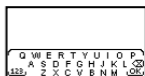

## BLUETOOTH

1. Appuyez sur les touches de direction pour activer le BLUETOOTH.
2. Appuyez sur ENTRER et l'écran visualisera le statut de connexion.
3. Connectez-vous à l'APP et utilisez-la pour vous connecter au testeur.

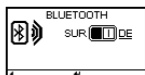

## COMPTEUR TEST

1. Appuyez sur les touches de direction pour accéder au COMPTEUR TEST.
2. Appuyez sur ↓ pour trouver IMPRIMER et imprimer l'enregistrement du compteur test.

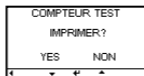
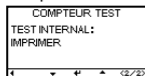
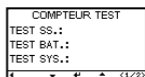

3. Appuyez sur ENTRER pour effacer les enregistrements spécifiques du compteur test.

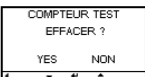



## GUIDE DE NAVIGATION PC

Chaque BT21000 est livré avec un CD, incluant le lecteur de l'installation du logiciel DHC SYNC et son guide utilisateur.

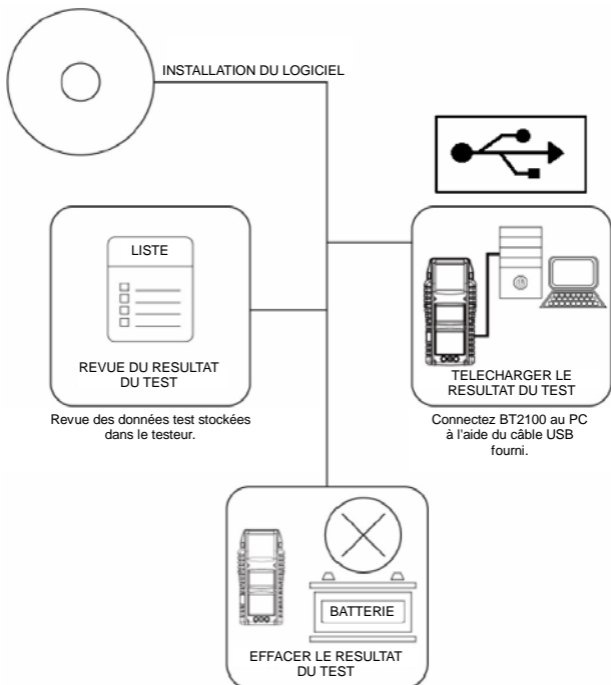

# DHC®

Modell BT2100

AKKU & ANALYSEGERÄT FÜR ELEKTRISCHE ANLAGEN



## BEDIENUNGSANLEITUNG

LESEN SIE VOR DER INBETRIEBNAHME DIESES PRODUKTS DIE GESAMTE  
BEDIENUNGSANLEITUNG DURCH

## TESTVERFAHREN/BEDIENUNGSANLEITUNG WICHTIG:

1. Zum Testen von 6- und 12-Volt-Akkus und Ladeysstemem mit 12 und 24 Volt.  
(NUR 12 Volt zum STARTEN & STOPPEN des Akkutests)
2. Zul. Betriebstemperatur 0°C (32°F) bis 50°C (122°F) bei Umgebungstemperatur.

- ① Temperatursensor
- ② Drucker
- ③ Display
- ④ Richtungstasten
- ⑤ USB-Port
- ⑥ Voltmeterbuchse
- ⑦ Buchse für die AMP-Klemme

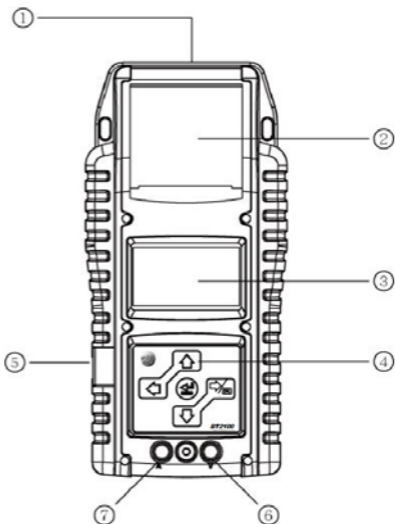

## **WARNUNG:**

Nach der kalifornischen Bestimmung 65 enthält dieses Produkt Chemikalien, die dem Bundesstaat Kalifornien als krebserregend bekannt sind und dass diese Geburtsschäden oder sonstige reproduktive Schäden verursachen. Nach dem Umgang die Hände waschen.

1. Gefahr bei der Arbeit in unmittelbarer Nähe von Bleiakkus. Während dem normalen Akkubetrieb erzeugen Akkus Explosionsgase. Aus diesem Grund ist es von größter Wichtigkeit, dass Sie bei Zweifel jedes Mal vor der Inbetriebnahme Ihres Prüfgeräts diese Anleitungen sehr aufmerksam durchlesen.
2. Um das Risiko einer Akkuexplosion zu vermeiden befolgen Sie diese Anleitungen und jene des Akkuherstellers und des Herstellers irgendwelcher Geräte, die Sie in der unmittelbaren Nähe des Akkus in Betrieb nehmen wollen. Beachten Sie die Sicherheitsangaben auf diesen Artikeln.
3. Das Prüfgerät vor Regen oder Schnee geschützt halten.

## **PERSONELLE SCHUTZMASSNAHMEN:**

1. Eine Person sollte sich im Bereich Ihrer Stimme oder nahe genug aufhalten, wenn Sie bei der Arbeit in der unmittelbaren Nähe eines Bleiakkus Hilfe benötigen.
2. Halten Sie ausreichend frisches Wasser und Seife in der unmittelbaren Nähe bereit, falls Ihre Haut, Kleidungen oder Augen mit der Akkusäure in Berührung kommen sollte.
3. Tragen Sie eine Sicherheitsbrille und Schutzkleidungen.
4. Falls die Akkusäure mit der Haut oder Kleidung in Berührung gekommen ist, waschen Sie diese unverzüglich mit Seife und Wasser. Falls die Akkusäure ins Auge gelangt ist, waschen Sie das Auge unverzüglich und mindestens zehn Minuten mit fließendem kalten Wasser aus und rufen unverzüglich einen Arzt.
5. Rauchen Sie NIEMALS und lassen keine Funken oder Flammen in unmittelbarer Nähe des Akkus oder des Motors entstehen.
6. Seien Sie besonders vorsichtig, um zu vermeiden, dass ein Metallwerkzeug auf den Akku fällt. Dies kann Funken oder einen Kurzschluss des Akkus oder anderer Elektroteile verursachen oder zu einer Explosion führen.
7. Entfernen Sie persönliche Gegenstände aus Metall, wie z.B. Ringe, Armbänder, Halsketten und Armbanduhren, wenn Sie mit einem Bleiakku arbeiten. Diese können einen Strom kurzschließen, der hoch genug ist, um einen Ring oder ähnlich zu schweißen, so dass dieses Metall schwere Verbrennungen verursachen kann.

## VORBEREITEN ZUM TEST

1. Achten Sie beim Testen des Akkus auf eine gute Belüftung um den Bereich um den Akku.
2. Reinigen Sie die Akkuklemmen. Achten Sie darauf, dass die Korrosion nicht mit den Augen in Berührung kommt.
3. Prüfen Sie den Akku auf Risse oder Schäden der Hülle. Verwenden Sie das Prüfgerät nicht, falls der Akku Schäden aufweist.
4. Falls der Akku nicht wartungsfrei abgedichtet ist, geben Sie destilliertes Wasser bei, bis die Akkusäure den vom Hersteller angegebenen Spiegel erreicht. Damit wird überschüssiges Gas aus den Zellen verdrängt. Nicht zu sehr auffüllen.
5. Der Akku muss zum Testen aus dem Fahrzeug entfernt werden. Entfernen Sie stets die Erdungsklemme vor dem Testen. Sicherstellen, dass sämtliches Zubehör im Fahrzeug ausgeschaltet ist, bevor Sie einen Funkendurchschlag durchführen.

## VOR DEM TEST

1. Vor dem Test eines Akkus in einem Fahrzeug schalten Sie die Zündung, sämtliches Zubehör und Ladungen aus. Schließen Sie alle Türen des Fahrzeuges und den Kofferraumdeckel.
2. Sicherstellen, dass 6 St. 1,5-Volt-Akkus in die Akkukammer eingesetzt wurden. Oxyrid-Akkus sind nicht empfohlen, da diese eine anfängliche Produktionsmenge von 1,7 Volt erzeugen. Falls die Ladung des 1,5-Volt-Akkus leer ist erscheint auf dem Schirm die Meldung "REPLACE INTERNAL BATTERY" (Internen Akku auswechseln) oder "POWER LOW" (Niedrige Ladung). Diese 6 St. der 1,5-Volt-Akkus vor dem Starten des Tests auswechseln.  
**Beachten Sie**, dass auf dem Display nichts erscheint, bis das Prüfgerät am Fahrzeugakku angeschlossen ist.
3. Sicherstellen, dass die Akkuklemmen sauber sind. Mit einer Drahtbürste reinigen, falls erforderlich. Das schwarze Kabel an die negative Akkuklemme im Fahrzeug anklemmen. Das rote Kabel an die positive Akkuklemme im Fahrzeug anklemmen. Nur auf den Bleiteil der Klemme anklemmen. Das Anklemmen auf den Eisenteil der Klemme führt zu falschen Testresultaten.

## 4. Papierladung:

- a. Den Klarsichtdeckel öffnen.
- b. Eine neue Papierrolle in das Fach einsetzen.
- c. Ein kurzes Stück Papier aus dem Fach schauen lassen und zum Schließen auf den Klarsichtdeckel drücken.



## TEST ZUM STARTEN/STOPPEN DES AKKUS

1. Zum Wählen von Test STARTEN-STOPPEN auf die ◀ Taste drücken.
2. Zum Wählen des Akkutyps auf die ◀ ▶ Taste drücken:
  - a. AGM PLATTE
  - b. EFBZum Bestätigen der Wahl auf "ENTER" (Eingabe) drücken.
3. Zum Wählen der Akku-Nennspannung auf die ◀ ▶ Taste drücken: CCA/SAE, EN, IEC oder DIN. Press "ENTER" button to confirm choice.

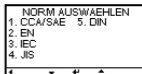
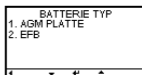

4. Zur Eingabe der Akkukapazität auf die ◀ ▶ Taste drücken:

SAE (CCA): 25 ~ 3,000

EN: 25 ~ 2,830

DIN: 25 ~ 1,685

IEC: 25 ~ 1,985

Zum Beginnen des Tests auf "ENTER" (Eingabe) drücken.

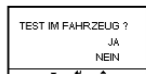

5. Zum Bestätigen des Standorts des Akkus auf die ◀ ▶ Taste drücken, falls eine Oberflächenladung erkannt wird. Die Anweisungen des Prüfgeräts befolgen, um die Oberflächenspannung zu entfernen.

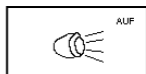

6. Richten Sie den "Temperaturmess-Sensor" 2,5 cm (1 Zoll) von der oberen Seite oder der Seite des Akkugehäuses und drücken auf "ENTER" (Eingabe). Die gemessene Temperatur kann sich durch die Distanz des Akkus von der Temperatur unter der Haube oder im Fach unterscheiden.

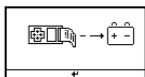

7. Den Akku testen.

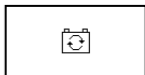

8. Zum Bestätigen, dass der Akku unlängst geladen wurde, drücken Sie auf die ◀ ▶ Taste.

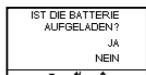

9. Nach dem Beenden des Tests wird das Resultat wie folgt auf dem Display angezeigt. {Zum Wählen auf die ◀ ▶ Taste drücken: Temperatur, SOH (GESUNDHETISZUSTAND) und SOC (LADUNGSZUSTAND)}.

## GUT & BESTANDEN

(GRÜNES Hintergrundlicht)

Der Akku ist in Ordnung und kann eine Ladung halten.



## GUT & NEU LADEN

(GRÜNES Hintergrundlicht)

Der Akku ist in Ordnung, muss jedoch neugeladen werden.

PRÜFUNGSRESULTATE	
GUT & AUFLADEN	
SOH:	
SOC:	
CCA:	
SPANNUNG:	

## NEU LADEN & ERNEUT TESTEN

(ORANGE Hintergrundlicht)

Der Akku wurde entladen, der Zustand des Akkus kann nicht bestimmt werden, bis dieser vollständig geladen wurde. Den Akku neu laden und den Test erneut durchführen.

PRÜFUNGSRESULTATE	
LADEN & PRÜEFEN	
SOH:	
SOC:	
CCA:	
SPANNUNG:	

## SCHLECHT & AUSWECHSELN

(ROTES Hintergrundlicht)

Der Akku wird keine Ladung halten. Dieser muss unverzüglich ausgewechselt werden.

PRÜFUNGSRESULTATE	
DEFEKT/ERSETZEN	
SOH:	
SOC:	
CCA:	
SPANNUNG:	

## SCHLECHTE ZELLE & AUSWECHSELN

(ROTES Hintergrundlicht)

Mindestens eine Zelle des Akkus ist kurzgeschlossen. Dieser muss unverzüglich ausgewechselt werden.

PRÜFUNGSRESULTATE	
ZELLE DEFEKT	
SOH:	
SOC:	
CCA:	
SPANNUNG:	

1. RO# und VIN#? YES (Ja) oder NO (Nein) hinzufügen. Wählen SIE YES (Ja), um die RO-Nummer und das Kennzeichen des Fahrzeuges einzugeben.

RO/VIN NUMMER									
----									
0	1	2	3	4					
5	6	7	8	9	OK				

KFZ-KENNZEICHEN									
-----									
0	1	2	3	4					
5	6	7	8	9	OK				

2. Zum Drucken des Resultats auf ENTER (Eingabe) drücken.

TEST DRUCKEN ?	
JA	
NEIN	



**HINWEIS:** Unter bestimmten Bedingungen werden die folgenden Meldungen angezeigt.



## FEHLER BEIM LADEN

Der getestete Akku übertrifft 3000 SAE (CCA) oder die Verbindung wurde nicht hergestellt. Die Kapazität des Akkus prüfen & sicherstellen dass die Klemmen richtig angeschlossen sind.

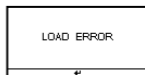

## KLEMME PRÜFEN

Die Verbindung zwischen dem Akku und dem Kabel ist zu lose. Die Kabelklemme prüfen.



## NIEDRIGE LADUNG DES AKKUS

Neue AA-Akkus wechseln.



## KEIN PAPIER

Eine neue Papierrolle einsetzen.

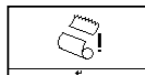

## HOHE SPANNUNG

Die Spannung des getesteten Akkus ist zu hoch und kann nicht gemessen werden.

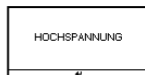

## UNSTABILE SPANNUNG

Die Spannung des gestesteten Akkus ist unstabil. Den Motor ausschalten, 90 Sekunden warten und den Test erneut durchführen.

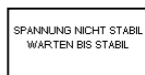

## AKKUTEST

1. Zum Wählen des Akkutests auf die ◀ ▶ Taste drücken.

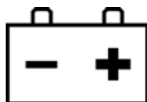

2. Zum Bestätigen der Akkuspannung auf die ◀ ▶ Taste drücken.



3. Zum Bestätigen, dass der Akku unlängst geladen wurde, drücken Sie auf die ◀ ▶ Taste.

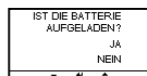

4. Zum Wählen des Akkutyps auf die ◀ ▶ Taste drücken:

- FLUESSIG-BATT
- AGM PLATTE
- AGM SPIRAL
- VRLA/GEL



Zum Bestätigen der Wahl auf "ENTER" (Eingabe) drücken.

5. Zum Wählen der Akku-Nennspannung auf die ◀ ▶ Taste drücken: CCA/SAE, EN, IEC oder DIN. Zum Bestätigen der Wahl auf "ENTER" (Eingabe) drücken.

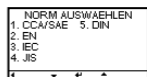

6. Zur Eingabe der Akkukapazität auf die ◀ ▶ Taste drücken:

- SAE (CCA): 25 ~ 3,000
- EN: 25 ~ 2,830
- DIN: 25 ~ 1,685
- IEC: 25 ~ 1,985
- JIS: Akkutyp-Nr.



Zum Beginnen des Tests auf "ENTER" (Eingabe) drücken.



7. Zum Bestätigen des Standorts des Akkus auf die ◀ ▶ Taste drücken, falls eine Oberflächenladung erkannt wird. Die Anweisungen des Prüfgeräts befolgen, um die Oberflächenspannung zu entfernen.

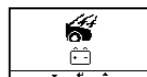

8. Richten Sie den "Temperaturmess-Sensor" 2,5 cm (1 Zoll) von der oberen Seite oder der Seite des Akkugehäuses und drücken auf "ENTER" (Eingabe). Die gemessene Temperatur kann sich durch die Distanz des

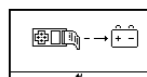

Akkus von der Temperatur unter der Haube oder im Fach unterscheiden.

9. Den Akku testen.

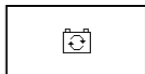

10. Nach dem Beenden des Tests wird im Display das folgende Resultat angezeigt. {Zum Wählen auf die ◀ ▶ Taste drücken: Temperatur, SOH (GESUNDHETISZUSTAND) und SOC (LADUNGSZUSTAND)}.

## GUT & BESTANDEN

Der Akku ist in Ordnung und kann eine Ladung halten.

PRÜFUNGSRESULTATE GUT & AUFLADEN SOH: SOC: CCA: SPANNUNG:
--

## GUT & NEU LADEN

Der Akku ist in Ordnung, muss jedoch neugeladen werden.

PRÜFUNGSRESULTATE GUT & BESTANDEN SOH: SOC: CCA: SPANNUNG:
---

## NEU LADEN & ERNEUT TESTEN

Der Akku wurde entladen, der Zustand des Akkus kann nicht bestimmt werden, bis dieser vollständig geladen wurde. Den Akku neu laden und den Test erneut durchführen.

PRÜFUNGSRESULTATE LADEN & PRÜEFEN SOH: SOC: CCA: SPANNUNG:
---

## SCHLECHT & AUSWECHSELN

Der Akku wird keine Ladung halten. Dieser muss unverzüglich ausgewechselt werden.

PRÜFUNGSRESULTATE DEFEKT/ERSETZEN SOH: SOC: CCA: SPANNUNG:
---

## SCHLECHTE ZELLE & AUSWECHSELN

Mindestens eine Zelle des Akkus ist kurzgeschlossen. Dieser muss unverzüglich ausgewechselt werden.

1. Zum Eingeben der RO-Nummer und des Kennzeichens des Fahrzeuges auf die ENTER-Taste (Eingabe) drücken.

PRÜFUNGSRESULTATE ZELLE DEFEKT SOH: SOC: CCA: SPANNUNG:
--

RO/VIN NUMMER									
-----									
0	1	2	3	4					
5	6	7	8	9					
ABC									OK

KFZ-KENNZEICHEN									
-----									
0	1	2	3	4					
5	6	7	8	9					
ABC									OK

2. Zum Drucken des Resultats auf ENTER (Eingabe) drücken.



**HINWEIS:** Unter bestimmten Bedingungen werden die folgenden Meldungen angezeigt.

## FEHLER BEIM LADEN

Der getestete Akku übertrifft 3000 SAE (CCA) oder die Verbindung wurde nicht hergestellt. Die Kapazität des Akkus prüfen & sicherstellen dass die Klemmen richtig angeschlossen sind.



## KLEMME PRÜFEN

Die Verbindung zwischen dem Akku und dem Kabel ist zu lose. Die Kabelklemme prüfen.



## NIEDRIGE LADUNG DES AKKUS

Neue AA-Akkus wechseln.



## KEIN PAPIER

Eine neue Papierrolle einsetzen.

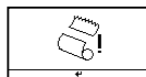

## HOHE SPANNUNG

Die Spannung des getesteten Akkus ist zu hoch und kann nicht gemessen werden.

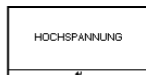

## UNSTABILE SPANNUNG

Die Spannung des gestesteten Akkus ist unstabil. Den Motor ausschalten, 90 Sekunden warten und den Test erneut durchführen.

SPANNUNG NICHT STABIL  
WARTEN BIS STABIL

## SYSTEMTEST

1. Zum Wählen des Akkutests auf die ◀ ▶ Taste drücken.



2. Sämtliche Ladungen des Zubehörs im Fahrzeug, wie z.B. Lampen, Klimaanlage, Radio usw. vor dem Anlassen des Motors ausschalten.

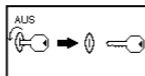
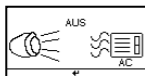

3. Beim Anlassen des Motors wird eines der drei Resultate zusammen mit dem tatsächlich gemessenen Resultat angezeigt.

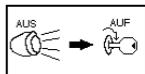

## NORMALE SPANNUNG BEIM ANLASSEN

Das System zeigt einen Normalwert an. Zum Durchführen des Ladesystemtests auf "ENTER" (Eingabe) drücken.

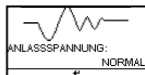

## NIEDRIGE SPANNUNG BEIM ANLASSEN

Die Spannung beim Anlassen ist unterhalb der normalen Grenzwerte. Führen Sie eine Fehlersuche nach dem vom Hersteller empfohlenen Vorgang durch.

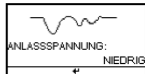

## SPANNUNG BEIM ANLASSEN NICHT ERKANNT

Die Spannung beim Anlassen wird nicht erkannt.

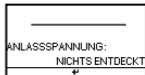

1. Falls die Spannung beim Anlassen normal ist, drücken Sie auf "ENTER" (Eingabe), um den Ladesystemtest zu beginnen.

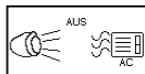

2. Auf die "ENTER"-Taste (Eingabe) drücken. Der folgende Schirm erscheint.
3. Auf die "ENTER"-Taste (Eingabe) drücken. Eines der drei Resultate wird zusammen mit dem tatsächlichen gemessenen Ablesewert angezeigt.

**HINWEIS:** Unter bestimmten Bedingungen werden die folgenden Meldungen angezeigt.

## NIEDRIGE LADESSPANNUNGEN BEI TEST IM LEERLAUF

Der Akku wird vom Generator nicht mit ausreichend Strom versorgt. Die Gurte prüfen, um sicherzustellen, dass der Generator rotiert wird, wenn der Motor läuft. Falls die Gurte rutschen oder beschädigt sind müssen diese ausgetauscht werden. Den Test erneut durchführen. Die Anschlüsse vom Generator zum Akku prüfen. Falls der Anschluss lose oder schwer korrodiert ist, muss das Kabel gereinigt oder ausgetauscht werden. Den Test erneut durchführen. Falls die Gurte oder Anschlüsse keine Schäden aufweisen, muss der Generator ausgetauscht werden.



## LADESYSTEM NORMAL BEI TEST IM LEERLAUF

Das System zeigt eine normale Leistung vom Generator. Es wurde kein Problem festgestellt.



## HOHE LADESSPANNUNGEN BEI TEST IM LEERLAUF

Die Spannungsleistung vom Generator zum Akku überschreitet die normalen Grenzwerte eines funktionierenden Reglers. Sicherstellen, dass der Anschluss nicht lose ist und der Erdungsanschluss normal ist. Falls der Anschluss keine Schäden aufweist, muss der Regler ausgetauscht werden. Da der Regler in den meisten Generatoren eingebaut ist, muss der Generator ausgetauscht werden. Der normale hohe Grenzwert eines typischen Auto-Reglers beträgt 14,7 Volt +/- 0,05. Prüfen Sie die Angaben des Herstellers für den richtigen Grenzwert, da dieser je nach Fahrzeugmodell und Hersteller unterschiedlich ist.



1. Nach dem Ladesystem im Leerlauf drücken Sie auf "ENTER" (Eingabe) für das Ladesystem mit den Belastungen des Zubehörs. Schalten Sie das Heizungsgebläse auf hoch, den Fortscheinwerfer auf stark und die Beheizung der Heckscheibe (falls damit ausgerüstet) ein. Verwenden Sie keine zyklische Belastungen, z.B. Klimaanlage oder Scheibenwischer.

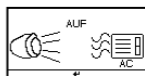

2. Beim Testen von älteren Dieselmotoren muss der Motor 15 Sekunden mit 2500 UPM laufengelassen werden. Der Schirm mit den Anleitungen des laufenden Motors erscheint.



3. Auf "ENTER" (Eingabe) drücken, um nach der Menge der Welligkeit vom Ladesystem zum Akku zu suchen. Eines der zwei Testresultate wird zusammen mit dem tatsächlich gemessenen Testresultat angezeigt.

## ERKANTE WELLIGKEIT NORMAL

Die Funktion der Dioden im Generator/Stator ist in Ordnung.

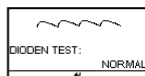

ODER

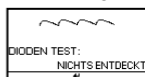

## ERKANTE UBERMASSIGE WELLIGKEIT

Eine oder mehr Dioden im Generator funktioniert/funktionieren nicht oder der Stator ist beschädigt. Sicherstellen, dass der Generator sicher montiert ist und dass die Gurte in gutem Zustand sind und einwandfrei funktionieren. Falls die Montage und Gurte keine Mängel aufweisen, muss der Generator ausgewechselt werden.

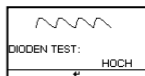

1. Auf "ENTER" (Eingabe) drücken, um das Ladesystem mit den Belastungen des Zubehörs fortzusetzen. One of the three results will be displayed along with the actual testing measured.



## LADESYSTEM NIEDRIG BEIM TEST MIT BELASTUNGEN DES ZUBEHÖRS

Die elektrischen Lasten werden vom Generator nicht mit ausreichend Strom und der Akku wird mit keinem ausreichenden Ladestrom versorgt. Die Gurte prüfen, um sicherzustellen, dass der Generator rotiert wird, wenn der Motor läuft. Falls die Gurte rutschen oder beschädigt sind müssen diese ausgewechselt werden, Den Test erneut durchführen. Die Anschlüsse vom Generator zum Akku prüfen. Falls der Anschluss lose oder schwer korridiert ist, muss das Kabel gereinigt oder ausgewechselt werden. Den Test erneut durchführen. Falls die Gurte und Anschlüsse keine Mängel aufweisen, muss der Generator ausgewechselt werden.



## LADESYSTEM NORMAL BEIM TEST MIT BELASTUNGEN DES ZUBEHÖRS

Das System zeigt eine normale Leistung des Generators an oder es wurde kein Problem festgestellt.



## LADESYSTEM HOCH BEIM TEST MIT BELASTUNGEN DES ZUBEHÖRS

Die Spannungsleistung vom Generator zum Akku überschreitet die normalen Grenzwerte eines funktionierenden Reglers. Sicherstellen, dass die Anschlüsse nicht lose sind und dass der Erdungsanschluss richtig angeschlossen wurde. Falls der Anschluss keine Schäden aufweist, muss der Regler ausgewechselt werden. Da der Regler in den meisten Generatoren eingebaut ist, muss der Generator ausgewechselt werden.

1. Nach dem Beenden des Tests wird im Display das folgende Resultat angezeigt.
2. Zum Drucken des Resultats auf ENTER (Eingabe) drücken.

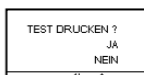
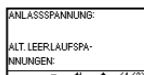
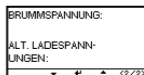

## IR-TEST

1. Zum Wählen des IR-TESTS auf die ◀ ▶ Taste drücken.

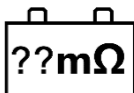

2. Zum Bestätigen der Akkuspannung auf die ◀ ▶ Taste drücken.



3. Zum Bestätigen, dass der Akku unlängst geladen wurde, drücken Sie auf die ◀ ▶ Taste.

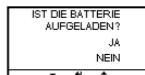

4. Falls der Akku NICHT geladen wurde, wählen Sie "NO" (Nein) aus, um neu zu laden und den Akku erneut zu testen. Falls der Akku geladen wurde, wählen Sie "YES" (Ja) und führen den Test durch.



5. Richten Sie den "Temperaturmess-Sensor" 2,5 cm (1 Zoll) von der oberen Seite oder der Seite des Akkugehäuses und drücken auf "ENTER" (Eingabe). Die gemessene Temperatur kann sich durch die Distanz des Akkus von der Temperatur unter der Haube oder im Fach unterscheiden.

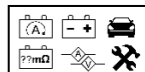

6. Den Akku testen.

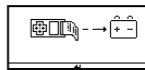

7. Nach dem Beenden des Tests wird im Display das folgende Resultat angezeigt.

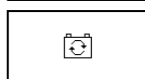

8. Zum Drucken des Resultats auf ENTER (Eingabe) drücken.

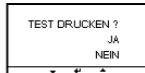
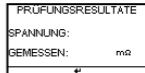

## VM/AM-TEST

### AM-TEST

1. Den 9V-Akku installieren.
2. Die Strommesszange an die Buchse A des BT2100 anschließen. Auf POWER drücken.
3. Auf die ZERO-Taste (Null) drücken. Sicherstellen, dass im Display Null angezeigt ist.
4. Auf den Auslöser drücken, um die Transformatorklemmbacken und die Klemme Eins der elektrischen Leitungen zu öffnen.
5. Sicherstellen, dass die Klemmbacken einwandfrei geschlossen sind.
6. Den angezeigten Wert ablesen.

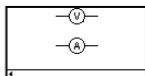
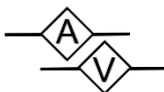

### VM-TEST

1. Die rote Prüfleitung an die Buchse V am BT2100 anschließen.
2. Mit der Prüfleitung eine Stelle innerhalb des Netzes des Akkus berühren.
3. Den angezeigten Wert ablesen.

**HINWEIS:** Keine Spannung von mehr als 60 V prüfen, da dadurch das Prüfgerät beschädigt werden kann.

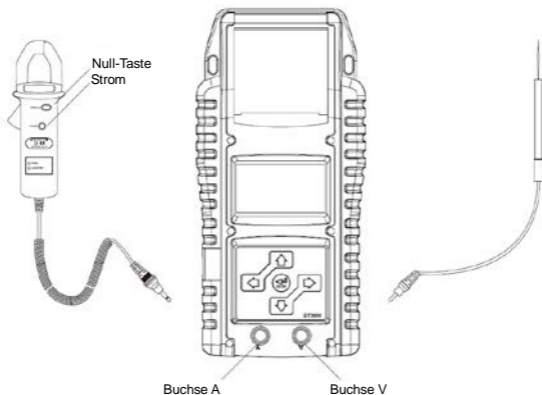

## ABRUF DER EINSTELLUNG UND DER INFORMATIONEN

Zum Wählen der Einstellung auf die ◀  
▶ Taste drücken.

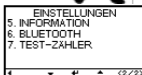

### LCD-HINTERGRUNDLICHT

1. Auf die Richtungstasten drücken, um zu LCD-HINTERGRUNDLICHT zu gelangen.
2. Auf die Richtungstasten drücken, um die Helligkeit des Displays einzustellen.
3. Auf ENTER (Eingabe) drücken, damit das Display zum Menü zurückkehrt.

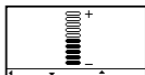

### SPRACHAUSWAHL

1. Auf die Richtungstasten drücken, um zum SPRACHAUSWAHL-Display zu gelangen.
2. Auf ENTER (Eingabe) drücken. Im Display erscheinen die Sprachoptionen. Auf die Richtungstasten drücken, um die gewünschte Sprache auszuwählen und in der das Prüfgerät die Meldungen im Display anzeigt.
3. Auf ENTER (Eingabe) drücken, damit das Display zum Menü zurückkehrt.

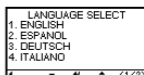

### DIE UHR EINSTELLEN

1. Auf die Richtungstaste drücken, um zum Display mit dem/der GEGENWÄRTIGEN DATUM/UHRZEIT zu gelangen.
2. Auf ENTER (Eingabe) drücken und JAHR/MONAT/DATUM/STUNDE/MINUTE/SEKUNDE auf der virtuellen Tastatur eingeben und die Einstellung abändern.
3. Auf ENTER (Eingabe) drücken, damit das Display zum Menü zurückkehrt.

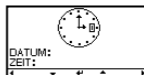

### SPEICHER LÖSCHEN

1. Auf die Richtungstasten drücken, um zu SPEICHER LÖSCHEN zu gelangen.
2. Zum Löschen des Speichers "JA" wählen.
3. Auf die "ENTER"-Taste (Eingabe) drücken. Das Display kehrt ins Menü zurück.

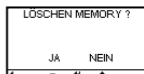

## INFORMATIONEN

1. Auf die Richtungstasten drücken, um zu INFORMATIONEN zu gelangen.
2. Die benutzerdefinierten Daten mit den Richtungstasten eingeben.
3. Auf die "ENTER"-Taste (Eingabe) drücken. Das Display kehrt ins Menü zurück.

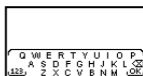

## BLUETOOTH

1. Auf die Richtungstasten drücken, um zu BLUETOOTH zu gelangen.
2. Auf ENTER (Eingabe) drücken. Im Display wird der Verbindungszustand angezeigt.
3. APP einloggen und mit diesem das Prüfgerät verbinden.

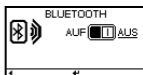

## TEST-ZÄHLER

1. Auf die Richtungstasten drücken, um zu TEST-ZÄHLER zu gelangen.
2. Auf ↓ drücken, um nach DRUCKEN zu suchen und den Bericht des Test-Zählers auszudrucken.

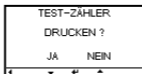
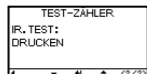
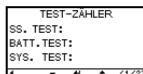

3. Auf ENTER (Eingabe) drücken, um die spezifischen Berichte des Test-Zählers zu löschen.

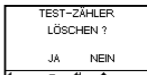

## PC-NAVIGATIONSFÜHRER

Jeder BT2100 wird mit einer CD mit dem Treiber für die Software-Installation DHC SYNC und dessen Bedienungsanleitung geliefert.

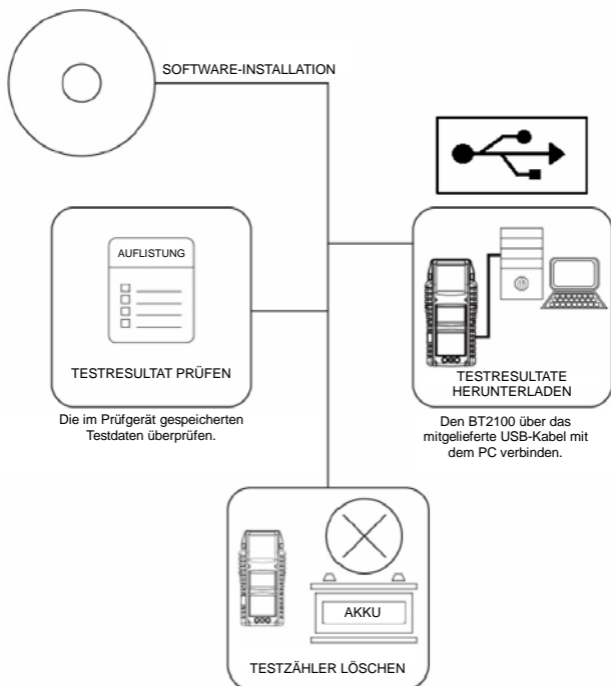

# DHC®

Modelo BT2100

ANALIZADOR DE SISTEMA ELÉCTRICO Y DE BATERÍA



## MANUAL DE USUARIO

LEA COMPLETAMENTE EL MANUAL ANTES DE UTILIZAR ESTE PRODUCTO

## PROCEDIMIENTO DE TEST/INSTRUCCIONES DE OPERACIÓN IMPORTANTE:

1. Para el test de baterías de 6 y 12 voltios, y de sistema de recarga de 12 y 24 voltios. (SOLO para el test de batería de ARRANQUE & DETENCIÓN)
2. El rango de operación sugerido 32°F (0°C) hasta 122°F (50°C) en temperatura ambiente.

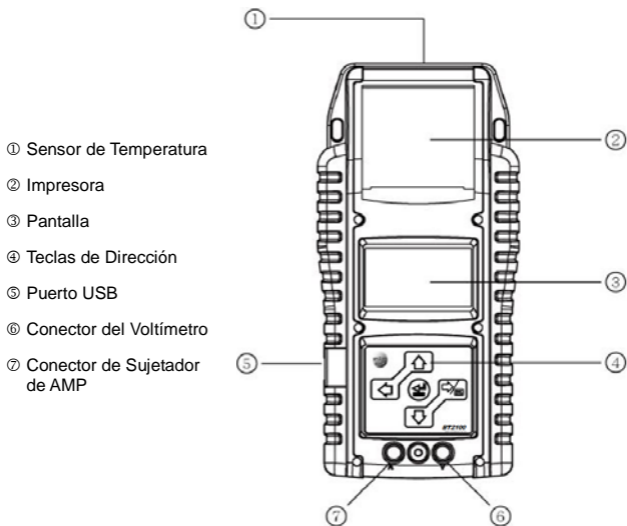



## **PRECAUCIÓN:**

Conforme a la Proposición Californiana numero 65, este producto contiene químicos conocidos por el Estado de California que causan cáncer y defectos de nacimiento u otros daños reproductivos. Lávese las manos después de utilizarlo.

1. Trabajar en la vecindad de la batería de carga de ácido es peligroso. Las baterías generan gases explosivos durante la operación normal de la batería. Por esta razón, es de vital importancia, si usted tiene alguna duda, cada vez antes de utilizar el probador, por favor lea estas instrucciones cuidadosamente.
2. Para reducir el riesgo de explosión de la batería, siga estas instrucciones y las publicadas por el fabricante de la batería y el fabricante de cualquier equipo que usted intente utilizar en la vecindad de la batería. Observe las advertencias marcadas en esos ítems.
3. No exponga el probador a la lluvia o a la nieve.

## **PRECAUCIONES DE SEGURIDAD PERSONALES:**

1. Alguien debe estar dentro del rango de su voz o lo suficientemente cerca para ir en su ayuda cuando trabaje cerca de la batería de carga de ácido.
2. Tenga mucha agua y jabón cerca en caso de que el ácido de la batería haga contacto con su piel, ropa o ojos.
3. Utilice gafas de seguridad y ropa protectora.
4. Si el ácido de la batería hace contacto con su piel o ropa, lave inmediatamente con agua y jabón. Si el ácido entra en el ojo, inmediatamente hunda el ojo en una corriente de agua fría por lo menos diez minutos y acuda donde el médico inmediatamente.
5. NUNCA fume o permita alguna chispa o llama en la vecindad de la batería y del motor.
6. Sea extra cuidadoso para reducir el riesgo de dejar caer alguna herramienta metálica dentro de la batería. Esto podría generar una chispa o hacer un corto en la batería o en alguna de las otras partes eléctricas y puede causar una explosión.
7. Retire sus ítems de metal personales como anillos, brazaletes, collares y relojes cuando trabaje con una batería de carga de ácido. Esto puede causar un corto circuito de alta corriente suficiente para fundir un anillo o algún metal causando una quemadura severa.

## PREPARACIÓN PARA EL TEST

1. Asegúrese que el área cerca de la batería está bien ventilada mientras la batería este siendo probada.
2. Limpie los terminales de la batería. Asegúrese de mantener la corrosión lejos de sus ojos.
3. Inspeccione la batería por grietas o daños en el cobertor. Si la batería esta dañada, no utilice el probador.
4. Si la batería no está sellada libre de mantenimiento, adicione agua destilada en cada celda hasta que el acido de la batería alcance el nivel especificado por el fabricante. Esto ayuda a purgar el gas excesivo de las celdas. No sobrellene.
5. Si es necesario retirar la batería desde el vehículo hasta el test, siempre retire el terminal de tierra desde la batería primero. Asegúrese que todos los accesorios en el vehículo estén apagados para asegurarse de no causar ningún arco.

## ANTES DEL TEST

1. Antes de probar la batería en un vehículo, apague la inyección todos los accesorios y las cargas. Cierre todas las puertas del vehículo y la tapa del maletero.
2. Asegúrese que haya colocado las 6 piezas de las baterías de 1.5V en la cámara de la batería. Baterías de Oxyride no son recomendadas por la salida inicial de 1.7 Voltios. Si la batería de 1.5V funciona fuera de poder, una pantalla se mostrara "REPLACE LA BATERÍA INTERNA" o "BAJO PODER". Remplace esas 6 piezas de las baterías de 1.5V antes de iniciar el test.  
**Note** que nada se podrá ver en la pantalla hasta que el probador esté conectado a la batería de un vehículo.
3. Asegúrese que los terminales de la batería estén limpios. Utilice un cepillo de alambre si es necesario. Enganche el cable de carga negro al terminal negativo de la batería del vehículo. Enganche el cable de carga rojo al terminal positivo de la batería del vehículo. Por favor enganche en la parte de la carga del terminal solamente. Enganchando en la parte de hierro del terminal con la carga para los resultados erróneos del test.

## 4. Carga de papel:

- a. Abra el cobertor transparente.
- b. Coloque un nuevo rollo de papel en el compartimiento.
- c. Coloque un pedazo pequeño de papel desde el compartimiento y presiónelo hacia abajo el cobertor transparente para cerrarlo.



## TEST DE ARRANQUE & DETENCIÓN DE LA BATERÍA

1. Presione la tecla ◀ ▶ para seleccionar el Test de ARRANQUE & DETENCIÓN.



2. Presione la tecla ◀ ▶ para seleccionar el tipo de batería:

- a. AGM PLANA
- b. EFB



Presione el botón "ENTER" para confirmar su selección.

3. Presione la tecla ◀ ▶ para seleccionar la clasificación de la batería: CCA/SAE, EN, IEC, o DIN. Presione el botón "ENTER" para confirmar su selección.

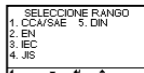

4. Presione la tecla ◀ ▶ para introducir la capacidad de la batería:

SAE (CCA): 25 ~ 3,000

EN: 25 ~ 2,830

DIN: 25 ~ 1,685

IEC: 25 ~ 1,985

Presione "ENTER" para comenzar el test.

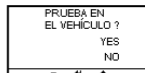
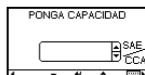

5. Presione la tecla ◀ ▶ para confirmar la localización de la batería si un cambio en la superficie es detectado, siguiendo las instrucciones del probador para retirar el cambio de la superficie.

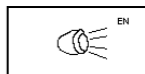
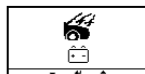

6. Apunte el "Sensor de Medición de Temperatura" a 2.5cm (1 pulgada) de la parte superior o de los lados del cobertor de la batería y presione "ENTER". La medición de la temperatura puede variar por la distancia de la batería, bajo condiciones de cubrimiento, y temperatura de gabinete.

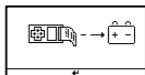

7. Probando la batería.

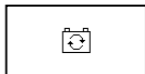

8. Presione la tecla ◀ ▶ para confirmar si la batería ha sido cargada recientemente.

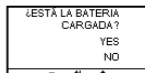

9. Cuando el test este completa, la pantalla mostrara los resultados como se muestra a continuación. {Presione la tecla ◀ ▶ para seleccionar: Temperatura, SOH (ESTADO DE SALUD), y SOC (ESTADO DE LA CARGA)}.

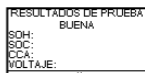

## BUENO & PASA

(Luz trasera VERDE)

La batería esta Buena y está capacitada para para mantener la carga.

## BUENA & RECARGAR

(Luz trasera VERDE)

La batería esta buena pero necesita ser recargada.

RESULTADOS DE PRUEBA
BUENA-RECARGAR
SOH:
SOC:
CCA:
VOLTAJE:

## RECARGAR & PROBAR

(Luz trasera NARANJA)

La batería esta descargada, la condición de la batería no podrá ser determinada hasta que está cargada completamente. Recargue & pruebe nuevamente.

RESULTADOS DE PRUEBA
RECARGAR-PROBAR
SOH:
SOC:
CCA:
VOLTAJE:

## MALA & REMPLAZAR

(Luz trasera ROJA)

La batería no mantendrá la carga. Debe ser reemplazada inmediatamente.

RESULTADOS DE PRUEBA
MALA-REEMPLAZAR
SOH:
SOC:
CCA:
VOLTAJE:

## ELEMENTO MALA & REMPLAZAR

(Luz trasera ROJA)

La batería tiene al menos una celda en corto circuito. Debe ser reemplazada inmediatamente.

RESULTADOS DE PRUEBA
ELEMENTO MALA
SOH:
SOC:
CCA:
VOLTAJE:

1. Agregue RO# y VIN#? SI o NO. Seleccione SI para introducir el número RO y el número de la placa del vehículo.

RO/VIN NÚMERO
----
0 1 2 3 4
5 6 7 8 9
ABC, OK

NO.: PLACA DE LA LICENCIA
----
0 1 2 3 4
5 6 7 8 9
ABC, OK

2. Presione ENTER para imprimir el test.

IMPRIMIR TEST ?
YES
NO



**NOTA:** Bajo ciertas condiciones el siguiente mensaje puede ser mostrado.

## ERROR DE CARGA

La batería probada es mayor que 3000 SAE (CCA) o la conexión no está estabilizada. Verifique la capacidad de la batería & asegúrese que los sujetadores estén apropiadamente conectadas.



## VERIFIQUE EL SUJETADOR

La conexión entre la batería y el set de cables están sueltos, por favor verifique el sujetador del cable.



## BATERÍA INTERNA BAJA

Por favor cargue las nuevas baterías AA.



## NO PAPEL

Por favor introduzca el nuevo rollo de papel.

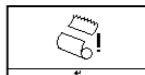

## ALTO VOLTAJE

El voltaje la batería probada está muy alto y no puede ser medida.



## VOLTAJE INESTABLE

El voltaje de la batería probada no es estable Por favor apague el motor, espere por 90 segundos y pruebe nuevamente.

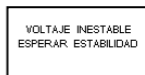

## TEST DE LA BATERÍA

1. Presione la tecla ◀ ▶ para seleccionar el Test de la Batería.
2. Presione la tecla ◀ ▶ para confirmar el voltaje de la batería.
3. Presione la tecla ◀ ▶ para confirmar si la batería ha sido cargada recientemente.
4. Presione la tecla ◀ ▶ para seleccionar el tipo de batería:
  - a. LÍQUIDO ESTÁNDAR
  - b. AMG PLANA
  - c. AMG ESPIRAL
  - d. VRLA/GELPresione "ENTER" para confirmar su elección.
5. Presione la tecla ◀ ▶ para seleccionar la clasificación de la batería: CCA/SAE, EN, IEC, o DIN. Presione "ENTER" para confirmar su elección.
6. Presione la tecla ◀ ▶ para introducir la capacidad de la batería:
  - SAE (CCA): 25 ~ 3,000
  - EN: 25 ~ 2,830
  - DIN: 25 ~ 1,685
  - IEC: 25 ~ 1,985
  - JIS: Tipo de Batería No.Presione "ENTER" para comenzar el test.
7. Presione la tecla ◀ ▶ para confirmar la localización de la batería si un cambio en la superficie es detectado, siguiendo las instrucciones del probador para retirar el cambio de la superficie.
8. Apunte el "Sensor de Medición de Temperatura" a 2.5cm (1 pulgada) de la parte superior o de los lados del cobertor de la batería y presione "ENTER". La medición de la temperatura puede variar por la distancia de la batería, bajo condiciones de cubrimiento, y temperature

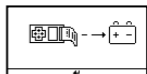
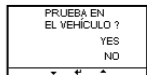
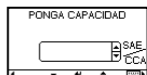
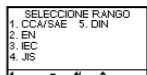
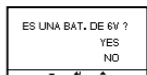
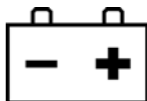

de gabinete.

9. Probando la batería.

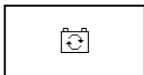

10. Cuando el test este completa, la pantalla mostrara los resultados como a continuación. {Presione la tecla ◀ ▶ para seleccionar: Temperatura, SOH (ESTADO DE SALUD), y SOC (ESTADO DE LA CARGA)}.



## BUENO & PASA

La bacteria esta Buena y está capacitada para para mantener la carga.

RESULTADOS DE PRUEBA
BUENA
SOH:
SOC:
CCA:
VOLTAJE:

## BUENA & RECARGAR

La batería esta buena pero necesita ser recargada.

RESULTADOS DE PRUEBA
BUENA-RECARGAR
SOH:
SOC:
CCA:
VOLTAJE:

## RECARGAR & PROBAR

La batería esta descargada, la condición de la batería no podrá ser determinada hasta que está cargada completamente. Recargue & pruebe nuevamente.

RESULTADOS DE PRUEBA
RECARGAR-PROBAR
SOH:
SOC:
CCA:
VOLTAJE:

## MALA & REPLAZAR

La batería no mantendrá la carga. Debe ser reemplazada inmediatamente.

RESULTADOS DE PRUEBA
MALA-REEMPLAZAR
SOH:
SOC:
CCA:
VOLTAJE:

## ELEMENTO MALA & REPLAZAR

La batería tiene al menos una celda en corto circuito. Debe ser reemplazada inmediatamente.

RESULTADOS DE PRUEBA
ELEMENTO MALA
SOH:
SOC:
CCA:
VOLTAJE:

1. Presione el botón ENTER para introducir el número RO y el número de placa del vehículo.

RO/VIN NÚMERO				
-----				
0	1	2	3	4
5	6	7	8	9
ABC				OK

NO.: PLACA DE LA LICENCIA				
-----				
0	1	2	3	4
5	6	7	8	9
ABC				OK

2. Presione ENTER para imprimir el test.

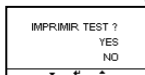

**NOTA:** Bajo ciertas condiciones el siguiente mensaje puede ser mostrado.

## ERROR DE CARGA

La batería probada es mayor que 3000 SAE (CCA) o la conexión no está estabilizada. Verifique la capacidad de la batería & asegúrese que los sujetadores estén apropiadamente conectadas.



## VERIFIQUE EL SUJETADOR

La conexión entre la batería y el set de cables están sueltos, por favor verifique el sujetador del cable.



## BATERÍA INTERNA BAJA

Por favor cargue las nuevas baterías AA.



## NO PAPEL

Por favor introduzca el nuevo rollo de papel.



## ALTO VOLTAJE

El voltaje la batería probada está muy alto y no puede ser medida.



## VOLTAJE INESTABLE

El voltaje de la batería probada no es estable. Por favor apague el motor, espere por 90 segundos y pruebe nuevamente.

VOLTAJE INESTABLE  
ESPERAR ESTABILIDAD

## TEST DEL SISTEMA

1. Presione la tecla ◀ ▶ para seleccionar el Test de la Batería.



2. Apague todas las cargas de accesorios del vehículo tales como luces, aire acondicionado, radio, etc. Antes de prender el motor.

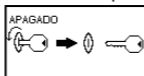
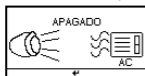

3. Cuando el motor es encendido, uno de los tres resultados se mostrará junto al resultado de medición actual.

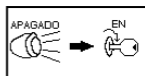

## VOLTIOS DE ARRANQUE NORMAL

El sistema está mostrando una gráfica normal. Presione "ENTER" para realizar el test del sistema de carga.

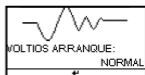

## VOLTIOS DE ARRANQUE BAJOS

El voltaje de arranque está por debajo de los límites normales, solucionar los problemas de arranque con las recomendaciones del fabricante.



## VOLTIOS DE ARRANQUE NO DETECTADOS

El voltaje de arranque no es detectado.

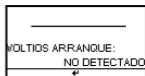

1. Si el voltaje de arranque es normal, presione "ENTER" para iniciar el test del sistema de carga.

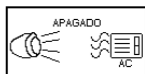

2. Presione la tecla "ENTER", verá la próxima pantalla.
3. Presione la tecla "ENTER", uno de los tres resultados será mostrado junto con la lectura de medición actual.

**NOTA:** Bajo ciertas condiciones el siguiente mensaje puede ser mostrado.

## VOLTIOS DE ARRANQUE BAJO CUANDO SE HACE EL TEST IDEAL

El alternador no está proporcionando suficiente corriente a la batería. Verifique las correas para asegurarse que el alternador este rotando con el motor encendido. Si las correas se están deslizando o están dañadas, reemplace las correas y pruebe nuevamente. Verifique las conexiones desde el alternador a la batería. Si la conexión esta suelta o muy corroída, límpiela o reemplace el cable y pruebe nuevamente. Si las correas y las conexiones están en buenas condiciones, reemplace el alternador.



## CARGA NORMAL DEL SISTEMA CUANDO SE HACE EL TEST IDEAL

El sistema está mostrando una salida normal desde el alternador, no se detecta ningún problema.



## VOLTIOS DE ARRANQUE ALTO CUANDO SE HACE EL TEST IDEAL

El voltaje de salida desde el alternador a la batería excede los límites normales de un regulador funcionando. Verifique si no hay conexiones sueltas y que la conexión de tierra sea normal. Si no hay problema en la conexión, reemplace el regulador. Debido a que la mayoría de los alternadores tienen un regulador interno esto requerirá que usted reemplace el alternador. El limite normal de un regulador típico de automóvil es 14.7 voltios +/- 0.05. Verifique las especificaciones del fabricante para los límites correctos, debido a que esta varía para el tipo de vehículo y fabricante.



1. Siguiendo la carga del sistema ideal, presione "ENTER" para la carga del sistema con los accesorios de cargas. Encienda el calentador en alto, luces frontales altas, y desempañado trasero (Si está equipado). No utilice cargas cíclicas como el aire acondicionado o los limpia brizas.

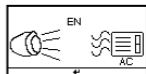

2. Cuando se prueban los modelos antiguos diesel, el usuario necesita calentar el motor a 2500rpm por 15 segundos. Vera la pantalla de instrucción del encendido del motor.



3. Presione "ENTER" para buscar la cantidad de risos desde el sistema de carga a la batería. Uno de los dos resultados de los tests será mostrado junto a la medición del test actual.

## RIZADO DETECTADO NORMAL

Las funciones de diodos son buenas en el alternador/estator.

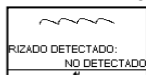
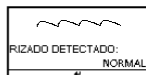

## RIZADO EXCESIVO DETECTADOS

Uno o más diodos en el alternador no están funcionando o hay un daño en el estator. Verifique para asegurarse que el montaje del alternador este bien fijado y que las correas estén en buen estado y funcionen apropiadamente. Si el montaje y las correas están bien, reemplace el alternador.

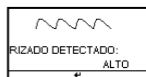

1. Presione la tecla "ENTER" para continuar la carga del sistema con los accesorios de cargas. Uno de los dos resultados de los tests será mostrado junto a la medición del test actual.

## CARGA BAJA DEL SISTEMA CUANDO SE HACE EL TEST IDEAL

El alternador no está entregando suficiente corriente para las cargas del sistema eléctrico y la corriente de carga de la batería. Verifique las correas para asegurarse que el alternador este rotando con el motor encendido. Si las correas se están deslizando o están dañadas, reemplace las correas y pruebe nuevamente. Verifique las conexiones desde el alternador a la batería. Si la conexión esta suelta o muy corroída, límpiela o remplace el cable y pruebe nuevamente. Si las correas y las conexiones están trabajando en buena condición, reemplace el alternador.



## CARGA NORMAL DEL SISTEMA CUANDO SE HACE EL TEST IDEAL

El sistema está mostrando una salida normal desde el alternador, no se detecto ningún problema.



## CARGA ALTA DEL SISTEMA CUANDO SE HACE EL TEST IDEAL

El voltaje de salida desde el alternador a la batería excede los límites normales de un regulador funcionando. Verifique para asegurarse que no haya ninguna conexión suelta y que la conexión a tierra este conectada apropiadamente. Si no hay problema en la conexión, reemplace el regulador. Debido a que la mayoría de los alternadores tienen un regulador interno esto requerirá que usted reemplace el alternador.



1. Cuando el test este completa, la pantalla mostrara los resultados como a continuación.

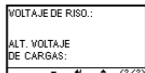

2. Presione ENTER para imprimir el test.

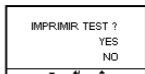

## TEST IR

1. Presione la tecla ◀ ▶ para seleccionar la TEST IR.
2. Presione la tecla ◀ ▶ para confirmar el voltaje de la batería.
3. Presione la tecla ◀ ▶ para confirmar si la batería ha sido cargada recientemente.
4. Si la batería NO ha sido cargada, por favor seleccione "NO" para recargar y probar nuevamente la batería. Si la batería ha sido cargada, por favor seleccione "YES" y proceda al test.
5. Apunte el "Sensor de Medición de Temperatura" a 2.5cm (1 pulgada) de la parte superior o de los lados del cobertor de la batería y presione "ENTER". La medición de la temperatura puede variar por la distancia de la batería, bajo condiciones de cubrimiento, y temperatura de gabinete.
6. Probando la batería.
7. Cuando el test este completa, la pantalla mostrara los resultados como a continuación.
8. Presione ENTER para imprimir el test.

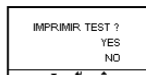
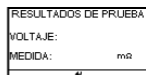
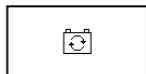
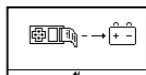
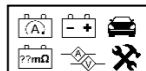
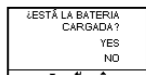
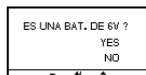
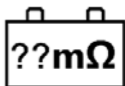

## TEST VM/AM

### TEST AM

1. Instalar la batería de 9V.
2. Conecte el Medidor del Sujetador al conector A en BT2100. Presione POWER.
3. Presione el botón ZERO. Asegúrese que se lea en la pantalla zero.
4. Presione el gatillo para abrir las mandíbulas del transformador y sujete un cable eléctrico.
5. Asegúrese que la mandíbula del sujetador está cerrada perfectamente.
6. Lea el valor de la pantalla.

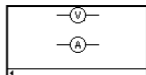

### TEST VM

1. Conecte el Cable Rojo del Probador a la mandíbula V en el BT2100.
2. Utilice el cable del probador para tocar un punto en la red de la batería.
3. Lea el valor de la pantalla.

NOTA: No realice tests para voltios mayores de 60V. Esto puede dañar el probador.

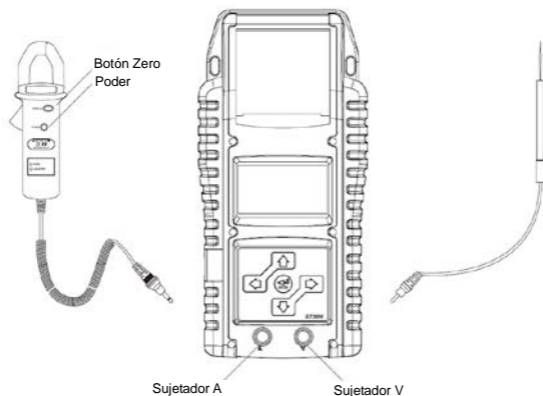



## CONFIGURACIÓN Y AJUSTE DE LA INFORMACIÓN

Presione la tecla ◀ ▶ para seleccionar la Configuración.

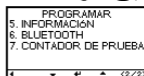
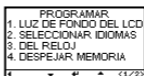

### LUZ DE FONDO DEL LCD

1. Presione las teclas direccionales para obtener la LUZ DE FONDO DEL LCD.
2. Presione las teclas direccionales para ajustar el brillo de la pantalla.
3. Presione ENTER y la pantalla regresara al menú.

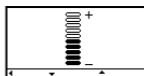

### SELECCIÓN DEL IDIOMA

1. Presione las teclas direccionales para llegar a la pantalla de SELECCIÓN DE IDIOMAS.
2. Presione ENTER y la pantalla mostrara las opciones de idiomas. Presione las teclas direccionales para seleccionar el idioma que desea que el probador muestre.
3. Presione ENTER y la pantalla regresara al menú.

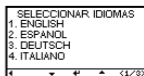

### CONFIGURACIÓN DEL RELOJ

1. Presione las teclas direccionales para llegar a la pantalla de la FECHA/HORA ACTUALES.
2. Presione ENTER y utilice el teclado virtual para ajustar el AÑO/MES/DÍA/HORA/MINUTOS/SEGUNDOS y cambiar la configuración.
3. Presione ENTER y la pantalla regresara al menú.



### BORRAR LA MEMORIA

1. Presione las teclas direccionales para llegar a BORRAR LA MEMORIA.
2. Seleccione "YES" para eliminar la memoria.
3. Presione el botón "ENTER" y la pantalla regresara al menú.

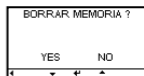

## INFORMACIÓN

1. Presione las teclas direccionales para entrar en la INFORMACIÓN.
2. Utilice la tecla direccional para personalizar el dato de entrada.
3. Presione el botón "ENTER" y la pantalla regresara al menú.

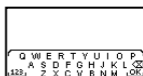

## BLUETOOTH

1. Presione las teclas direccionales para entrar a BLUETOOTH.
2. Presione ENTER y la pantalla mostrara el estado de la conexión.
3. Entre a la APLICACIÓN y utilícelo para conectar el probador.



## CONTADOR DE TEST

1. Presione las teclas direccionales para entrar al CONTADOR DE TEST.
2. Presione ↓ para encontrar IMPRIMIR e imprima historial del contador de test.

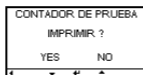
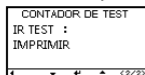
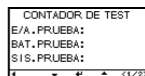

3. Presione ENTER para eliminar un historial específico del contador de test.

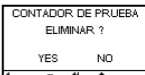

## GUÍA DE NAVEGACIÓN DEL PC

Cada BT2100 viene con un CD, incluye el driver de instalación del programa DHC SYNC y su manual de usuario.

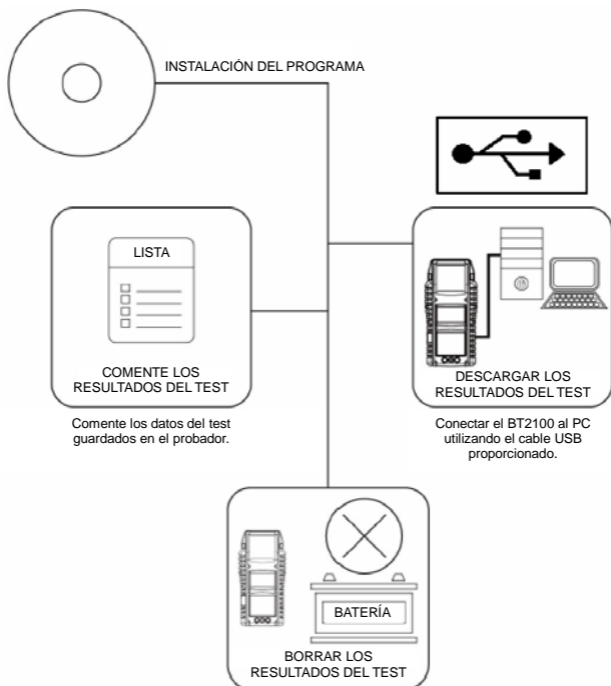

# DHC®

Modello BT2100

TESTER PER BATTERIE E SISTEMI ELETTRICI



## MANUALE UTENTE

LEGGERE IL MANUALE PER INTERO PRIMA DI UTILIZZARE QUESTO PRODOTTO

## PROCEDURE DI TEST/ISTRUZIONI OPERATIVE IMPORTANTE:

1. Uso per test di batterie a 6 e 12 volt, e sistemi di carica a 12 e 24 volt. (SOLO 12 volt per test batteria START E STOP)
2. Temperatura operativa suggerita da 0°C (32°F) a 50°C (122°F) a temperatura ambiente.

- ① Sensore Temperatura
- ② Stampante
- ③ Display
- ④ Tasti Direzionali
- ⑤ Porta USB
- ⑥ Presa Voltmetro
- ⑦ Presa Morsetto Amperometrico

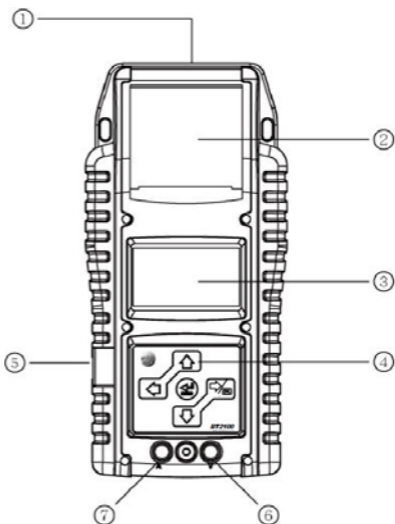

## AVVISO:

In conformità con la California Proposition 65 (Stati Uniti), si informa che questo prodotto contiene sostanze chimiche che lo Stato della California riconosce come causa di cancro, malformazioni congenite o altri danni agli organi riproduttivi. Lavare le mani dopo l'uso.

1. Lavorare in prossimità di una batteria al piombo-acido è pericoloso. Le batterie generano gas esplosivi durante il loro normale funzionamento. Per questo motivo, in presenza di qualsiasi dubbio, è estremamente importante leggere queste istruzioni molto attentamente prima di ogni uso del tester.
2. Per ridurre i rischi di esplosione della batteria, seguire attentamente le istruzioni di questo manuale, del manuale pubblicato dal produttore della batteria, e del produttore di qualsiasi dispositivo o strumento che si intende usare in prossimità della batteria. Osservare le istruzioni cautelative indicate sui dispositivi.
3. Non esporre il tester a pioggia o neve.

## PRECAUZIONI PER LA SICUREZZA PERSONALE:

1. Quando si lavora in prossimità di una batteria al piombo-acido, è necessario che vi sia qualcuno nelle vicinanze, a portata di voce, o abbastanza vicino da poter accorrere e fornire assistenza.
2. Assicurarsi che nelle vicinanze siano disponibili acqua e sapone in quantità, in caso di contatto dell'acido della batteria con cute, indumenti o occhi.
3. Indossare occhiali di sicurezza ed indumenti protettivi.
4. In caso di contatto dell'acido della batteria con cute o indumenti, lavare immediatamente l'area interessata con acqua e sapone. In caso di contatto con gli occhi, lavare gli occhi con acqua fredda corrente per almeno dieci minuti, quindi rivolgersi immediatamente ad un medico.
5. NON fumare o generare fiamme libere o scintille in prossimità della batteria o del motore.
6. Prestare estrema attenzione per ridurre il rischio di caduta di un oggetto di metallo sulla batteria. Il contatto potrebbe creare una scintilla o provocare il cortocircuito della batteria o di altre parti elettroniche, causando un'esplosione.
7. Rimuovere oggetti personali metallici come anelli, braccialetti, collane ed orologi prima di lavorare in prossimità di una batteria al piombo-acido. La corrente di cortocircuito prodotta potrebbe essere così elevata da fondere anelli o altri oggetti metallici, causando gravi ustioni.

## PREPARAZIONE AL TEST

1. Assicurarsi che l'area nelle vicinanze della batteria sia ben ventilata durante il test.
2. Pulire i terminali della batteria. Fare attenzione per assicurarsi che agenti corrosivi non entrino in contatto con gli occhi.
3. Ispezionare la batteria e assicurarsi che non siano presenti crepe o spaccature sul vano o sul coperchio. Non usare il tester se la batteria è danneggiata.
4. Qualora la batteria non fosse sigillata ed esente da manutenzione, aggiungere acqua distillata a ciascuna cella della batteria, e assicurarsi che l'acido della batteria raggiunga il livello specificato dal costruttore. Questa operazione serve ad epurare gas in eccesso dalle celle. Non oltrepassare il livello consigliato.
5. In caso sia necessario rimuovere la batteria dal veicolo per effettuare il test, prima di tutto rimuovere sempre il terminale di terra dalla batteria. Assicurarsi che tutti gli accessori nel veicolo siano spenti per evitare ionizzazione.

## PRIMA DEL TEST

1. Prima di effettuare il test di una batteria che si trova in un veicolo, spegnere il motore, tutti gli accessori e carichi. Chiudere tutte le porte del veicolo e lo sportello del bagagliaio.
2. Assicurarsi di aver posizionato 6 pezzi di batterie da 1,5 V nel vano batterie. Si raccomanda di non usare batterie Oxyride, perché presentano un valore di uscita iniziale di 1,7 Volt. Quando la batteria da 1,5 V è scarica, sullo schermo verrà visualizzato il messaggio "SOSTITUIRE BATTERIA INTERNA" o "BATTERIA SCARSA". Sostituire le batterie 1,5 V prima di iniziare il test.

**Nota** che il display non visualizzerà alcun messaggio fino a quando il tester non sarà connesso alla batteria del veicolo.

3. Assicurarsi che i terminali della batteria siano puliti. Se necessario, pulirli con una spazzola metallica. Connettere il morsetto nero al terminale negativo della batteria. Connettere il morsetto rosso al terminale positivo della batteria. Collegare il morsetto esclusivamente alla parte in piombo del terminale. Connettendo il morsetto alla parte in ferro del terminale, i risultati del test non saranno attendibili.

## 4. Inserimento carta:

a. Aprire il coperchio trasparente.



b. Inserire un nuovo rullo di carta nel compartimento.



c. Srotolare una piccola quantità di carta in modo che fuoriesca dal vano e richiudere il coperchio trasparente premendo verso il basso.



## TEST BATTERIA START-STOP

1. Premere i tasti ◀ ▶ per selezionare Test START-STOP.



2. Premere i tasti ◀ ▶ per selezionare il tipo di batteria:

a. AGM FLAT PLATE

b. EFB

Premere il tasto "INVIO" per confermare la selezione.

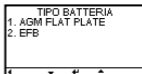

3. Premere i tasti ◀ ▶ per selezionare lo standard della batteria: CCA/SAE, EN, IEC, o DIN. Premere il tasto "INVIO" per confermare la selezione.

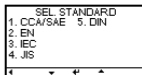



4. Premere i tasti ◀ ▶ per immettere la capacità della batteria:

SAE (CCA): 25 ~ 3,000

EN: 25 ~ 2,830

DIN: 25 ~ 1,685

IEC: 25 ~ 1,985

Premere "INVIO" per iniziare il test.

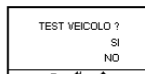

5. Premere i tasti ◀ ▶ per confermare la posizione della batteria in caso venga rilevata una carica superficiale, quindi seguire le istruzioni del tester per rimuovere la carica superficiale.

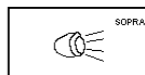

6. Puntare il "Sensore per la Misurazione della Temperatura" a 2,5 cm (1 pollice) di distanza dal lato superiore o dai lati del vano della batteria e premere "INVIO". La temperatura misurata potrebbe variare in base alla distanza dalla batteria, alle condizioni del vano motore e alla temperatura del vano.

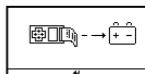

7. Test batteria.



8. Premere i tasti ◀ ▶ per confermare se la batteria è stata ricaricata recentemente.

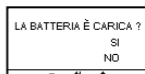

9. Una volta completato il test, i risultati verranno visualizzati sul display. {Premere i tasti ◀ ▶ per selezionare: Temperatura, SOH (STATE OF HEALTH: Stato di Salute) e SOC (STATE OF CHARGE: Stato della Carica)}.

## BATT. EFFICIENTE

(Retroilluminazione VERDE)

La batteria è in buono stato ed è in grado di mantenere la carica.

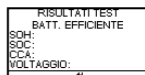

## BUONA & RICARICA

(Retroilluminazione VERDE)

La batteria è in buono stato ma deve essere ricaricata.

RISULTATI TEST	
BUONA & RICARICA	
SOH:	
SOC:	
CCA:	
VOLTAGGIO:	
↵	

## RICARICA. RITESTA

(Retroilluminazione ARANCIONE)

La batteria è scarica. Non è possibile determinare le condizioni della batteria fino a quando non verrà completamente ricaricata. Ricaricare la batteria e ripetere il test.

RISULTATI TEST	
RICARICA. RITESTA	
SOH:	
SOC:	
CCA:	
VOLTAGGIO:	
↵	

## DIFETT. SOSTIT.

(Retroilluminazione ROSSA)

La batteria non è in grado di mantenere la carica. È necessario sostituirla immediatamente.

RISULTATI TEST	
DIFETT. SOSTIT.	
SOH:	
SOC:	
CCA:	
VOLTAGGIO:	
↵	

## CELLA DIF. SOST.

(Retroilluminazione ROSSA)

La batteria presenta almeno una cella in cortocircuito. È necessario sostituirla immediatamente.

RISULTATI TEST	
CELLA DIF. SOST.	
SOH:	
SOC:	
CCA:	
VOLTAGGIO:	
↵	

1. Aggiungere numero RO e VIN? Selezionare SÌ e immettere il numero RO e il numero di immatricolazione.

RO/VIN NUMERO									
-----									
0	1	2	3	4					
5	6	7	8	9	↵	OK			
ABC									

NO: IMMATRICOLAZIONE									
-----									
0	1	2	3	4					
5	6	7	8	9	↵	OK			
ABC									

2. Premere INVIO per stampare i risultati.

STAMPA TEST ?	
SI	
NO	
↵	



**NOTA:** In particolari condizioni, è possibile che vengano visualizzati i seguenti messaggi.

## CCA FUORILIMITE O COLLEG ERRATO

La batteria testata è più grande di 3000 SAE (CCA), oppure non è stato possibile stabilire la connessione. Controllare la capacità della batteria ed assicurarsi che i connettori siano posizionati correttamente.

CCA FUORILIMITE O  
COLLEG ERRATO

## CONTROLLO MORSETTO

Vi è un errore di connessione tra la batteria ed i cavi. Controllare la connessione dei cavi dei morsetti.

  
CONTROLLO MORSETTO

## BATTERIA INTERNA SCARSA

Sostituire le batterie AA.

  
BATTERIA INTERNA SCARSA

## MANCA CARTA

Inserire un nuovo rullo di carta.



## TENSIONE ALTA

La tensione della batteria testata è troppo alta ed è impossibile misurarla.

TENSIONE ALTA

## TENSIONE NON STABILE ATTENDERE STABILIZZAZIONE

La tensione della batteria testata non è stabile. Spegner il motore, attendere 90 secondi e ripetere il test.

TENSIONE NON STABILE  
ATTENDERE  
STABILIZZAZIONE

## TEST BATTERIA

1. Premere i tasti ◀ ▶ per selezionare Test Batteria.
2. Premere i tasti ◀ ▶ per confermare il voltaggio della batteria.
3. Premere i tasti ◀ ▶ per confermare se la batteria è stata ricaricata recentemente.
4. Premere i tasti ◀ ▶ per selezionare il tipo di batteria:
  - a. LIQUIDO STANDARD
  - b. AGM FLAT PLATE
  - c. AGM SPIRALE
  - d. VRLA/GEL
 Premere "INVIO" per confermare la selezione.
5. Premere i tasti ◀ ▶ per selezionare lo standard della batteria: CCA/SAE, EN, IEC, o DIN. Premere "INVIO" per confermare la selezione.
6. Premere i tasti ◀ ▶ per immettere la capacità della batteria:
  - SAE (CCA): 25 ~ 3,000
  - EN: 25 ~ 2,830
  - DIN: 25 ~ 1,685
  - IEC: 25 ~ 1,985
  - JIS: Num. Tipo Batteria
 Premere "INVIO" per iniziare il test.
7. Premere i tasti ◀ ▶ per confermare la posizione della batteria in caso venga rilevata una carica superficiale, quindi seguire le istruzioni del tester per rimuovere la carica superficiale.
8. Puntare il "Sensore per la Misurazione della Temperatura" a 2,5 cm (1 pollice) di distanza dal lato superiore o dai lati del vano della batteria e premere "INVIO". La temperatura misurata potrebbe variare in base alla distanza dalla batteria, alle condizioni del vano

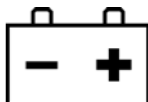

È UNA BATTERIA 6V ?  
SI  
NO

LA BATTERIA È CARICA ?  
SI  
NO

TIPO BATTERIA  
1. LIQUIDO STANDARD  
2. AGM FLAT PLATE  
3. AGM SPIRALE  
4. VRLA / GEL

SEL. STANDARD  
1. CCA/SAE 5. DIN  
2. EN  
3. IEC  
4. JIS

SEL. CAPACITÀ

SAE  
CCA

TEST VEICOLO ?  
SI  
NO

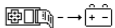

motore e alla temperatura del vano.

9. Test batteria.



10. Una volta completato il test, i risultati verranno visualizzati sul display come segue. {Premere i tasti ◀ ▶ per selezionare: Temperatura, SOH (STATE OF HEALTH: Stato di Salute) e SOC (STATE OF CHARGE: Stato della Carica)}.

## BATT. EFFICIENTE

La batteria è in buono stato ed è in grado di mantenere la carica.

RISULTATI TEST	
BATT. EFFICIENTE	
SOH:	
SOC:	
CCA:	
VOLTAGGIO:	

## BUONA & RICARICA

La batteria è in buono stato ma deve essere ricaricata.

RISULTATI TEST	
BUONA & RICARICA	
SOH:	
SOC:	
CCA:	
VOLTAGGIO:	

## RICARICA. RITESTA

La batteria è scarica. Non è possibile determinare le condizioni della batteria fino a quando non verrà completamente ricaricata. Ricaricare la batteria e ripetere il test.

RISULTATI TEST	
RICARICA. RITESTA	
SOH:	
SOC:	
CCA:	
VOLTAGGIO:	

## DIFETT. SOSTIT.

La batteria non è in grado di mantenere la carica. È necessario sostituirla immediatamente.

RISULTATI TEST	
DIFETT. SOSTIT.	
SOH:	
SOC:	
CCA:	
VOLTAGGIO:	

## CELLA DIF. SOST.

La batteria presenta almeno una cella in cortocircuito. È necessario sostituirla immediatamente.

RISULTATI TEST	
CELLA DIF. SOST.	
SOH:	
SOC:	
CCA:	
VOLTAGGIO:	

1. Premere il tasto INVIO per immettere il numero RO e il numero di

RO/VIN NUMERO					
-----					
0	1	2	3	4	
5	6	7	8	9	OK

NO: IMMATRICOLAZIONE					
-----					
0	1	2	3	4	
5	6	7	8	9	OK

2. Premere INVIO per stampare i risultati.

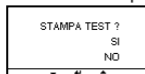

**NOTA:** In particolari condizioni, è possibile che vengano visualizzati i seguenti messaggi.

## CCA FUORILIMITE O COLLEG ERRATO

La batteria testata è più grande di 3000 SAE (CCA), oppure non è stato possibile stabilire la connessione. Controllare la capacità della batteria ed assicurarsi che i connettori siano posizionati correttamente.



## CONTROLLO MORSETTO

Vi è un errore di connessione tra la batteria ed i cavi. Controllare la connessione dei cavi dei morsetti.



## BATTERIA INTERNA SCARSA

Sostituire le batterie AA.



## MANCA CARTA

Inserire un nuovo rullo di carta.

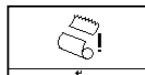

## TENSIONE ALTA

La tensione della batteria testata è troppo alta ed è impossibile misurarla.



## TENSIONE NON STABILE ATTENDERE STABILIZZAZIONE

La tensione della batteria testata non è stabile. Spegnerne il motore, attendere 90 secondi e ripetere il test.

TENSIONE NON STABILE  
ATTENDERE  
STABILIZZAZIONE

## TEST SISTEMA

1. Premere i tasti ◀ ▶ per selezionare Test Batteria.



2. Spegnerne tutti gli accessori del veicolo, come le luci, l'aria condizionata, la radio, ecc. prima di accendere il motore.

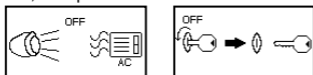

3. Quando si accende il motore, si visualizzerà uno dei tre risultati sullo schermo, insieme alle misurazioni rilevate.

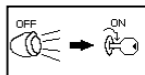

## TENS. AVVIAMENTO: NORMALE

Il sistema presenta un grafico nella norma. Premere "INVIO" per effettuare il test del sistema di ricarica.

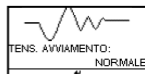

## TENS. AVVIAMENTO: BASSA

La tensione di avviamento è inferiore ai limiti di funzionamento regolare. Eseguire un controllo del dispositivo di avviamento secondo le procedure di risoluzione problemi suggerite dal produttore.

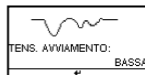

## TENS. AVVIAMENTO: NON RILEVATO

Non è possibile rilevare la tensione di avviamento.

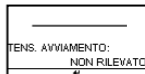



1. Se la tensione di avviamento è nella norma, premere "INVIO" per iniziare il test del sistema di ricarica.

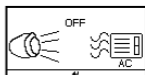

2. Premendo il tasto "INVIO", si visualizzerà la seguente schermata.
3. Premendo il tasto "INVIO", si visualizzerà uno dei tre risultati sullo schermo, insieme alle misurazioni rilevate.

**NOTA:** In particolari condizioni, è possibile che vengano visualizzati i seguenti messaggi.

## ALT. TENSION AL MINIMO: BASSA

La tensione dell'alternatore non è sufficiente per l'alimentazione della batteria. Controllare le cinghie per assicurarsi che l'alternatore ruoti regolarmente quando il motore è in funzionamento. Se le cinghie sono danneggiate o slittano, sostituire le cinghie e ripetere il test. Controllare la connessione tra l'alternatore e la batteria. Se la connessione è allentata o presenta segni eccessivi di corrosione, pulire o sostituire il cavo, quindi ripetere il test. Se le cinghie e la connessione non presentano problemi, sostituire l'alternatore.



## ALT. TENSION AL MINIMO: NORMALE

Il sistema presenta una tensione di uscita nella norma per l'alternatore. Nessun problema rilevato.



## ALT. TENSION AL MINIMO: ELEVATO

La tensione di uscita dall'alternatore alla batteria supera i limiti di un regolatore in funzionamento. Assicurarsi che la connessione non sia allentata e che la messa a terra funzioni correttamente. In caso non vi sia nessun problema alla connessione, sostituire il regolatore. La maggior parte degli alternatori presenta un regolatore incorporato. In questo caso, sarà necessario sostituire l'alternatore. Normalmente il limite superiore di un tipico regolatore automobilistico è di 17,4 volt, +/- 0,05. Controllare le specifiche del produttore per assicurarsi del limite corretto. Il limite può variare in base al tipo di veicolo e al costruttore.



1. Selezionando il sistema di carica al minimo, premere "INVIO" per il sistema di carica con accessori. Accendere il riscaldamento e posizionarlo al massimo, accendere gli abbaglianti e lo sbrinatori posteriore (qualora il veicolo ne sia provvisto). Non attivare carichi ciclici come aria condizionata o tergicristalli.

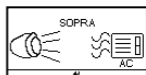

2. Quando si effettua il test su motori diesel di vecchio modello, l'utente deve far girare il motore a 2500 rpm per 15 secondi. Verrà visualizzata la schermata con le relative istruzioni.



3. Premere "INVIO" per visualizzare la quantità di ripple dal sistema di carica alla batteria. Si visualizzerà uno dei due risultati del test, insieme alle misurazioni rilevate.

## SEGNALE ALTERNATORE: NORMALE

I diodi dell'alternatore/statore funzionano correttamente.

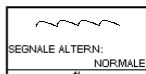

OPPURE



## SEGNALE ALTERNATORE: ELEVATO

Uno o più diodi dell'alternatore non sono funzionanti o lo statore è danneggiato. Assicurarsi che il supporto dell'alternatore sia fissato correttamente e che le cinghie siano in condizioni ottimali e che funzionino correttamente. Se il supporto e le cinghie non presentano problemi, sostituire l'alternatore.

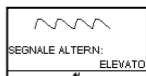

1. Premere il tasto "INVIO" per continuare il test sul sistema di carica con accessori. Si visualizzerà uno dei tre risultati del test, insieme alle misurazioni rilevate.

## ALT. TENSIONE DI CARICO: BASSA

La tensione dell'alternatore non è sufficiente per l'alimentazione dei carichi elettrici del sistema e per la corrente di carica della batteria. Controllare le cinghie per assicurarsi che l'alternatore ruoti regolarmente quando il motore è in funzionamento. Se le cinghie sono danneggiate o slittano, sostituire le cinghie e ripetere il test. Controllare la connessione tra l'alternatore e la batteria. Se la connessione è allentata o presenta segni eccessivi di corrosione, pulire o sostituire il cavo, quindi ripetere il test. Se le cinghie e le condizioni non presentano problemi, sostituire l'alternatore.



## ALT. TENSIONE DI CARICO: NORMALE

Il sistema presenta una normale tensione in uscita dall'alternatore. Nessun problema rilevato.



## ALT. TENSIONE DI CARICO: ALTA

La tensione di uscita dall'alternatore alla batteria supera i limiti di un regolatore in funzionamento. Assicurarsi che le connessioni non siano allentate e che la messa a terra sia connessa correttamente. In caso non vi sia nessun problema alla connessione, sostituire il regolatore. La maggior parte degli alternatori presenta un regolatore incorporato. In questo caso, sarà necessario sostituire l'alternatore.

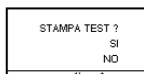
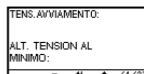

1. Una volta completato il test, i risultati verranno visualizzati sul display come segue.
2. Premere INVIO per stampare i risultati.

## TEST IR

1. Premere i tasti ◀ ▶ per selezionare TEST IR.
2. Premere i tasti ◀ ▶ per confermare il voltaggio della batteria.
3. Premere i tasti ◀ ▶ per confermare se la batteria è stata ricaricata recentemente.
4. Se la batteria NON è stata ancora ricaricata, selezionare "NO" per ricaricare e ripetere il test della batteria. Se la batteria è stata già ricaricata, selezionare "SI" per procedere con il test.
5. Puntare il "Sensore per la Misurazione della Temperatura" a 2,5 cm (1 pollice) di distanza dal lato superiore o dai lati del vano della batteria e premere "INVIO". La temperatura misurata potrebbe variare in base alla distanza dalla batteria, alle condizioni del vano motore e alla temperatura del vano.
6. Test batteria.
7. Una volta completato il test, i risultati verranno visualizzati sul display come segue.
8. Premere INVIO per stampare i risultati.

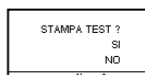
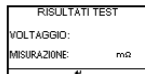
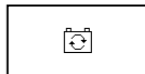
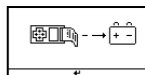
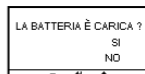
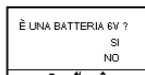
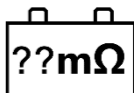

## TEST VM/AM

### TEST AM

1. Installare la batteria da 9V.
2. Connettere il morsetto amperometrico allo spinotto A su BT2100. Premere POWER.
3. Premere il tasto ZERO. Assicurarsi che la lettura sul display sia zero.
4. Premere la leva per aprire le ganasce del trasformatore e serrarle un filo elettrico.
5. Assicurarsi che le ganasce siano completamente chiuse.
6. Leggere il valore sul display.

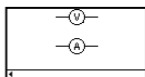

### TEST VM

1. Connettere il Puntale Rosso allo spinotto V su BT2100.
2. Usare il puntale di test per toccare un punto sulla rete della batteria.
3. Leggere il valore sul display.

NOTA: Non testare una tensione superiore a 60 V per evitare di danneggiare il tester.

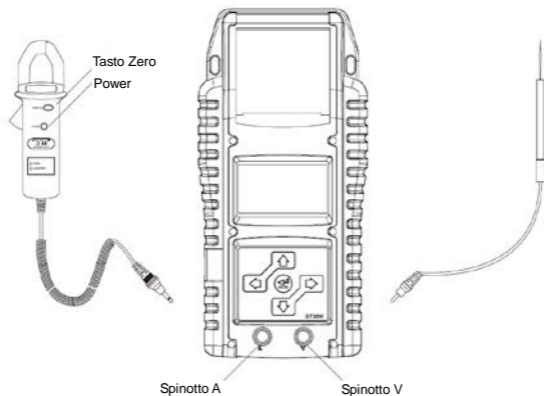

## IMPOSTAZIONI

Premere i tasti ◀ ▶ per selezionare le Impostazioni.

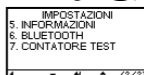
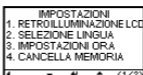

### RETROILLUMINAZIONE LCD

1. Premere i tasti direzionali per accedere alla schermata RETROILLUMINAZIONE LCD.
2. Premere i tasti direzionali per regolare la luminosità del display.
3. Premere INVIO per ritornare al menù precedente.

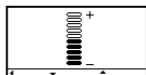

### SELEZIONE LINGUA

1. Premere i tasti direzionali per accedere alla schermata SELEZIONE LINGUA.
2. Premere INVIO per visualizzare le opzioni relative alle lingue. Premere i tasti direzionali per selezionare la lingua desiderata.
3. Premere INVIO per ritornare al menù precedente.

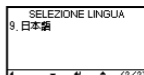

### IMPOSTAZIONI ORA

1. Premere i tasti direzionali per accedere alla schermata IMPOSTAZIONI ORA.
2. Premere INVIO e usare il tastierino virtuale per regolare ANNO/MESE/GIORNO/ORA/MINUTO/SECONDI e cambiare le impostazioni.
3. Premere INVIO per ritornare al menù precedente.

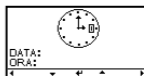

### CANCELLA MEMORIA

1. Premere i tasti direzionali per accedere alla schermata CANCELLA MEMORIA.
2. Selezionare "SI" per cancellare la memoria.
3. Premere il tasto "INVIO" per ritornare al menù precedente.

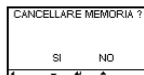

## INFORMAZIONI

1. Premere i tasti direzionali per accedere alla schermata INFORMAZIONI.
2. Usare i tasti direzionali per immettere i dati personalizzati.
3. Premere il tasto "INVIO" per ritornare al menù precedente.

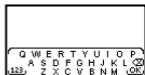

## BLUETOOTH

1. Premere i tasti direzionali per accedere alla schermata BLUETOOTH.
2. Premere INVIO e per visualizzare lo stato della connessione.
3. Aprire l'applicazione e connettere il tester.



## CONTATORE TEST

1. Premere i tasti direzionali per accedere alla schermata CONTATORE TEST.

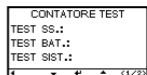

2. Premere ↓ per selezionare l'opzione di STAMPA e stampare il rapporto del contatore test.

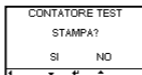
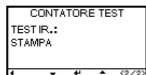

3. Premere INVIO per eliminare rapporti specifici del contatore test.

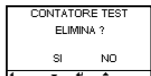

## GUIDA NAVIGAZIONE PC

I dispositivi BT2100 sono accompagnati da un CD contenente i driver del software di installazione DHC SYNC ed il relativo manuale utente.

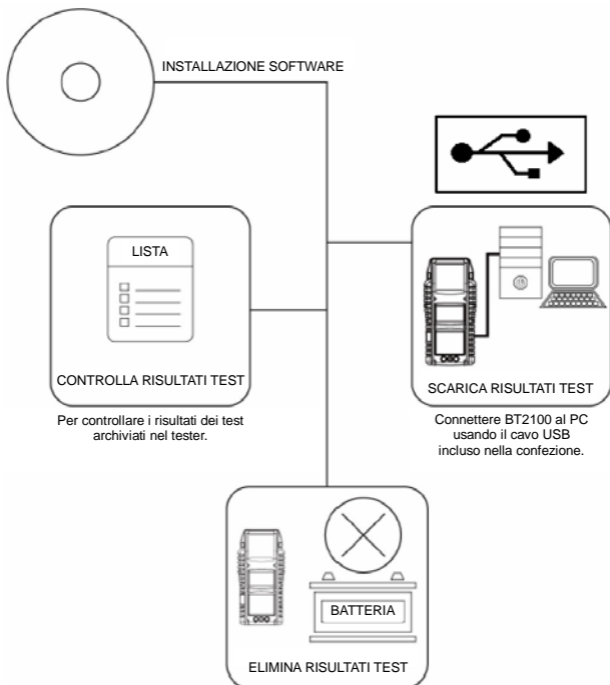



# DHC<sup>®</sup>

Modelo BT2100

BATERIA & ANALISADOR DO SISTEMA ELÉCTRICO



## MANUAL DO USUÁRIO

LEIA O MANUAL COMPLETAMENTE ANTES DE UTILIZAR ESSE PRODUTO

## PROCEDIMENTOS DE TESTES/INSTRUÇÕES DE USO IMPORTANTE:

1. Para testes de baterias de 6 e 12V, e sistemas de carregamento de 12 e 24.  
(Apenas 12V para COMEÇAR & PARAR teste de bateria)
2. Operação sugerida varia de 32°F (0°C) a 122°F (50°C) em temperatura ambiente.

- ① Sensor de temperatura
- ② Impressora
- ③ Tela
- ④ Chaves de direção
- ⑤ Porta de USB
- ⑥ Voltímetro Jack
- ⑦ Grampo AMP Jack

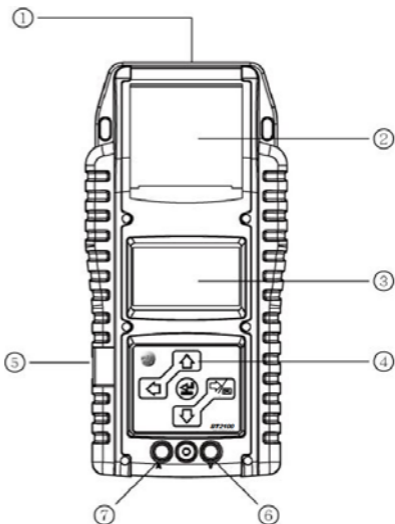

## **ATENÇÃO:**

Porsuidores da preposição 65 da Califórnia, este produto contém químicos conhecidos pelo estado da Califórnia por causar cancer, problemas no nascimento de crianças e outros prejuízos reprodutivos. Lave as mãos antes de utilizá-lo.

1. Trabalhar perto de bateria de ácido de chumbo é perigoso. Baterias geram gases explosivos durante sua operação normal. Por esta razão, é de extrema importância, se tiveres qualquer dúvida, cada vez antes de utilizar o seu testador, leia as instruções com cuidado.
2. Para reduzir o risco de explosão da bateria, siga essas instruções e as publicadas no produtor da baterias e no produtor de qualquer equipamento pretendidos a serem usados nas redondezas da bateria. Observe cuidadosamente as marcas nesses itens.
3. Não exponha o testador a chuva ou neve.

## **CUIDADOS PARA SEGURANÇA PESSOAL:**

1. Você deve ter alguém a sua volta ou o suficiente perto para te ajudar quando você estiver trabalhando perto de uma bateria de ácido chumbo.
2. Tenha bastante água potável e sabão por perto em caso de o ácido da bateria entre em contato com a pele, roupa ou olhos.
3. Vista óculos e roupas de proteção.
4. Se o ácido da bateria entrar em contato com a pele ou roupa, lave imediatamente com sabão e água. Se o ácido entrar em contato com os olhos, lave os olhos com água corrente fria por no mínimo 10 minutos e obtenha assistência médica imediatamente.
5. NUNCA fume or permita qualquer tipo de faísca ou chama de fogo nas redondezas da bateria ou máquina.
6. Tenha muito cuidado para não deixar nenhuma ferramenta de metal cair dentro da bateria. Isso poderia causar um curto-circuito na bateria ou outras partes elétricas e causar uma explosão.
7. Remova itens pessoais como anel, pulseira, colar e relógio quando estiver trabalhando com o bateria de ácido de chumbo. Isso pode produzir um curto-circuito grande o suficiente para soldar o anel o outro metal causando uma queimada severa.

## PREPARANDO PARA O TESTE

1. Tenha certeza de que a área em volta da bateria está bastante ventilada enquanto a bateria estiver sendo testada.
2. Limpar os terminais da bateria. Tenha cuidado para que corrosão não entre em contato com os olhos.
3. Inspeccione a bateria para verificar se existem trincados ou quebrados em sua capa. Se a bateria estiver estragada, não use o testador.
4. Se a bateria não estiver selada sem manutenção, adicione água destilada em cada célula até o nível do ácido da bateria alcançar nível especificado pelo produtor. Isso ajuda a purgar gás excessivo das células. Não encha até derramar.
5. Se necessário para remover a bateria do veículo de teste, sempre remova o terminal de terra da bateria primeiro. Tenha certeza de que todos os acessórios no veículo estejam desligados para ter certeza que não será causado nenhum tipo de arqueamento.

## ANTES DO TESTE

1. Antes de testar a bateria em um veículo, deligue a ignição e todos os acessórios e carregamentos. Feche todas as portas do veículo e a porta do bagageiro.
2. Tenha certeza que você colocou 6pcs de baterias 1.5V dentro da camera da bateria. Baterias de oxídio não são recomendadas por cause do valor de saída de 1.7V. Se a bateria de 1.5V acabar a bateria, aparecerá na tela "TROCAR A BATERIA INTERNA" ou "BATERIA BAIXA". Troque os 6pcs de baterias 1.5V antes de começar o teste.  
**Note** que nada aparecerá na tela até que o testador estiver conectado na bateria do veículo.
3. Tenha certeza que os terminais das baterias estejam limpos. Passe empomja de aço neles se for necessário. Prenda a cabo preto ao veículo no terminal da bateria negativo. Prenda o cabo vermelho ao veículo no terminal da bateria positivo. Por favor, prenda na parte de chumbo do terminal apenas. Prendendo na parade de aço do terminal resultará em resultados errôneos.

#### 4. Carregamento de papel:

a. Abra a tampa.



b. Coloque o novo rolo de papel no compartimento.



c. Coloque um pedaço de papel curto do compartimento e pressione para baixo a tampa para fechar.



## INICIAR-TERMINAR TESTE DE BATERIA

1. Pressione a chave ◀ ▶ para selecionar o teste de INICIAR-TERMINAR.

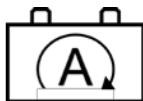

2. Pressione a chave ◀ ▶ para selecionar o tipo de bateria:

a. AGM PLANA

b. EFB

Pressione o botão "ENTRA" para confirmar escolha.



3. Pressione a chave ◀ ▶ para SELEC. PADRAO: CCA/SAE, EN, IEC, ou DIN. Pressione o botão "ENTRA" para confirmar escolha.

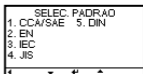

4. Pressione a chave ◀ ▶ para colocar a CAPACIDADE da bateria:

SAE (CCA): 25 ~ 3,000

EN: 25 ~ 2,830

DIN: 25 ~ 1,685

IEC: 25 ~ 1,985

Pressione SIM para começar o teste.

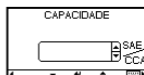

5. Pressione a chave ◀ ▶ para confirmar a localização da bateria se a superfície de carga for detectada, siga as direções do testador para remover a carga da superfície.

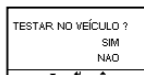

6. Aponte a "Temperatura de medida do sensor" 2.5cm (1 inch) do topo ou lados da capa da bateria e pressione "Enter". Medidas da temperatura vão varias de acordo com a distância da bateria, abaixo das condições do capu, e temperatura do gabinete.



7. Testando a bateria.

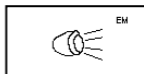

8. Pressione a chave ◀ ▶ SIM para confirmar se a bateria foi carregada recentemente.

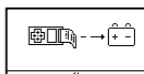

9. Quando o teste estiver completo, a tela vai mostrar os resultados seguintes. {Pressione a chave ◀ ▶ para selecionar: Temperatura, SOH (ESTADO DE SAÚDE), e SOC (ESTADO DE CARREGAMENTO)}.

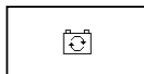

## BOM & PASSAR

(VERDE luz de fundo)

A bateria esta boa e capaz de segurar carga.

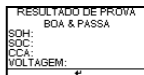

## BOM & RECARREGAR

(VERDE luz de fundo)

A bateria está boa mas precisa ser recarregada.

RESULTADO DE PROVA BOA & CARREGUE
SOH:
SOC:
CCA:
VOLTAGEM:

## RECARREGAR & RETESTAR

(LARANJA luz de fundo)

Bateria está descarregada, a condição da bateria não pode ser determinada até que a bateria estiver totalmente carregada. Recarregar & retestar a bateria.

RESULTADO DE PROVA CARREGUE & TESTE
SOH:
SOC:
CCA:
VOLTAGEM:

## RUIM & TROCAR

(VERMELHO luz traseira)

A bateria não irá segurar carga. A bateria devera ser substituída imediatamente.

RESULTADO DE PROVA RUIM & SUBSTITUA
SOH:
SOC:
CCA:
VOLTAGEM:

## CÉLULA RUIM & SUBSTITUIR

(VERMELHO luz traseira)

A bateria tem no mínimo uma célula de curto-circuito. A bateria deve ser trocada imediatamente.

RESULTADO DE PROVA CEL. RUIM-SUBST.
SOH:
SOC:
CCA:
VOLTAGEM:

1. Adicione RO/VIN SIM ou NÃO. Para selecionar SIM para entrar o RO/VIN Número e NO.: DA LICENSA DA PLACA.

RO/VIN NÚMERO
----
0 1 2 3 4
5 6 7 8 9
ABC) (OK)

NO.: DA LICENSA DA PLACA
-----
0 1 2 3 4
5 6 7 8 9
ABC) (OK)

2. Pressione ENTRA para imprimir o teste.

IMPRIMIR. TESTE ?
SIM
NAO



**NOTA:** Em certas condições as seguintes mensagens irão aparecer na tela.

## ERRO DE CARGA

O teste da bateria é maior do que 3000 SAE (CCA) ou a conexão não foi estabelecida. Verificar a capacidade da bateria & ter certeza de que as braçadeiras estão devidamente conectadas.

ERRO DE CARGA

## CHECAR A BRAÇADEIRA

A conexão da bateria e do cabo estão folgadas, por favor checar o cabo da braçadeira.

  
CHECAR A BRAÇADEIRA

## BATERIA INTERNA BAIXA

Mudar para novas baterias AA.

  
BATERIA INTERNA BAIXA

## SEM PAPEL

Insira mais papel.



## ALTA VOLTAGEM

A voltagem da bateria testada está muito alta ou não pode ser medida.

ALTA VOLTAGEM

## VOLTAGEM INSTÁVEL

A voltagem da bateria testada é instável. Por favor desligue a máquina, espere por 90 segundos e teste novamente.

VOLTAGEM INSTÁVEL  
ESPERAR PARA  
ESTABILIZAR



## TESTE DE BATERIA

1. Pressione a chave ◀ ▶ para selecionar bateria de teste.
2. Pressione a chave ◀ ▶ para confirmar a voltagem da bateria.
3. Pressione a chave ◀ ▶ SIM para confirmar se a bateria foi carregada recentemente.
4. Pressione a chave ◀ ▶ para selecionar o tipo de bateria:
  - a. LIQUIDO STANDARD
  - b. AGM PLANA
  - c. AGM ESPIRAL
  - d. VRLA/GELPressione **ENTRA** para confirmar a escolha.
5. Pressione a chave ◀ ▶ para SELEC. PADRAO: CCA/SAE, EN, IEC, ou DIN. Pressione **ENTRA** para confirmar a escolha.
6. Pressione a chave ◀ ▶ para colocar a CAPACIDADE da bateria:
  - SAE (CCA): 25 ~ 3,000
  - EN: 25 ~ 2,830
  - DIN: 25 ~ 1,685
  - IEC: 25 ~ 1,985
  - JIS: No. do tipo de bateriaPressione **SIM** para começar o teste.
7. Pressione a chave ◀ ▶ para confirmar a localização da bateria se a superfície de carga for detectada, siga as direções do testador para remover a carga da superfície.
8. Aponte a "Temperatura de medida do sensor" 2.5cm (1 inch) do topo ou lados da capa da bateria e pressione "Enter". Medidas da temperatura vão varias de acordo com a distância da bateria, abaixo das condições do capu, e temperatura do gabinete.

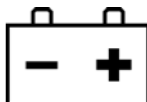

ISSO É UMA BATERIA 6V ?  
SIM  
NAO

A BATERIA ESTÁ  
CARREGADA ?  
SIM  
NAO

TIPO DE BATERIA  
1. LIQUIDO STANDARD  
2. AGM PLANA  
3. AGM ESPIRAL  
4. VRLA / GEL

SELEC. PADRAO  
1. CCA/SAE 5. DIN  
2. EN  
3. IEC  
4. JIS

CAPACIDADE  
[Barra deslizante] SAE  
CCA

TESTAR NO VEÍCULO ?  
SIM  
NAO

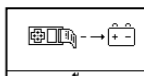

9. Testando a bateria.

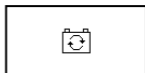

10. Quando o teste estiver completo, a tela mostrará os resultados seguintes. {Pressione a chave ◀ ▶ para selecionar: Temperatura, SOH (ESTADO DE SAÚDE), e SOC (ESTADO DE CARREGAMENTO)}.

## BOM & PASSAR

A bateria esta boa e capaz de segurar carga.

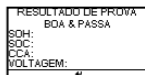

## BOM & RECARREGAR

A bateria está boa mas precisa ser recarregada.

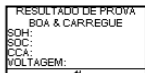

## RECARREGAR & RETESTAR

Bateria está descarregada, a condição da bateria não pode ser determinada até que a bateria estiver totalmente carregada. Recarregar & retestar a bateria.

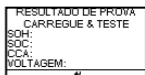

## RUIM & TROCAR

A bateria não irá segurar carga. A bateria devera ser substituída imediatamente.

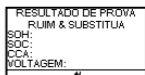

## CÉLULA RUIM & SUBSTITUIR

A bateria tem no mínimo uma célula de curto-circuito. A bateria deve ser trocada imediatamente.

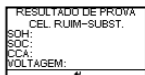

1. Pressione o botão para entrar no RO/VIN NUMERO ou NO.: DA LICENSA DA PLACA.

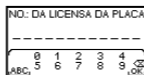
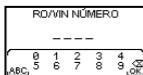

2. Pressione **ENTRA** para imprimir o teste.



**NOTA:** Em certas condições as seguintes mensagens irão aparecer na tela.

## ERRO DE CARGA

O teste da bateria é maior do que 3000 SAE (CCA) ou a conexão não foi estabelecida. Verificar a capacidade da bateria & ter certeza de que as braçadeiras estão devidamente conectadas.



## CHECAR A BRAÇADEIRA

A conexão da bateria e do cabo estão folgadas, por favor checar o cabo da braçadeira.



## BATERIA INTERNA BAIXA

Mudar para novas baterias AA.



## SEM PAPEL

Insira mais papel.



## ALTA VOLTAGEM

A voltagem da bateria testada está muito alta ou não pode ser medida.

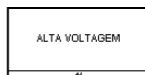

## VOLTAGEM INSTÁVEL

A voltagem da bateria testada é instável. Por favor desligue a máquina, espere por 90 segundos e teste novamente.

VOLTAGEM INSTÁVEL  
ESPERAR PARA  
ESTABILIZAR

## TESTE DO SISTEMA

1. Pressione a chave ◀ ▶ para selecionar bateria de teste.



2. Desligue os acessórios do veículo como as luzes, ar condicionado, radio, etc. antes de dar ignição.

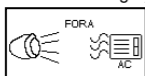

3. Quando o motor estiver ligado, um dos três resultados irá aparecer na tela com o resultado atual medido.

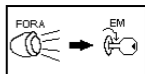

## VOLTS DE PARTIDA NORMAL

O Sistema está mostrando desenhos normais. Pressione ENTRAR para realizar o teste do sistema de carregamento.

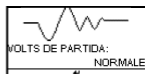

## VOLTS DE PARTIDA BAIXO

Os volts de partida está abaixo dos limites normais, solucionar os problemas de acordo com as recomendações do fabricante.

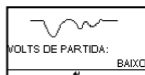

## VOLTS DE PARTIDA NAO DETECTADO

O volts de partida não foram detectados.

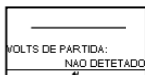

1. Se o volts de partida está normal, pressione "Enter" para começar o teste de carregamento do Sistema.

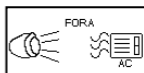

2. Pressione a chave "ENTER" e você verá a seguinte tela.
3. Pressione a chave "ENTER". Um dos três resultados seguintes irá aparecer juntamente com a leitura medida atual.

**NOTA:** Em certas condições as seguintes mensagens irão aparecer na tela.

## BAIXA VOLTS DE CARREGAMENTO QUANDO TESTE EM OCIOSO

O alternador não está provendo suficiente carga para a bateria. Checar os cintos para ter certeza de que o alternador está rodando com o motor em modo ligado. Se os cintos estiverem deslizando ou quebrados, troque-os e teste novamente. Checar as conexões do alternador com a bateria. Se as conexões estiverem frouxas ou muito corroídas, limpe-as ou troque o cabo e teste novamente. Se os cintos e as conexão estão em boas condições, troque o alternador.



## SISTEMA DE CARREGAMENTO NORMAL QUANDO TESTE ESTÁ EM OCIOSO

O Sistema está mostrando saída normal do alternador, nenhum problema foi detectado.



## ALTA VOLTS DE CARREGAMENTO QUANDO TESTE EM OCIOSO

A voltagem de saída do alternador para a bateria ultrapassa os limites normais de um regulador em funcionamento. Checar e ter certeza se não tem nenhuma conexão frouxa e que a conexão com o solo está normal. Se não tiver problemas com a conexão, substituir o regulador. Já que a maioria dos alternadores tem um regulador embutido, isto irá requerer a substituição do alternador. O limite normal alto de um regulador automotivo é 14.7 volts +/-0.05. Checar as especificações do produtor para o limite correto, já que isso variará de acordo com o tipo de veículo e produtor.

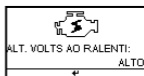

1. Seguindo o Sistema de carregamento em ocioso, pressione "ENTER" para o Sistema de carregamento com acessórios carregados. Ligue o ventilador de aquecimento em alta temperatura, faróis de máximos e desembaciador traseiro (se equipado). Não use os carregamentos cíclicos como ar condicionado e limpadores de para-brisa.

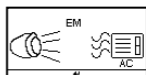

2. Quando testando máquinas velhas de óleo a diesel, o usuário precisa ligar a máquina em 2500 rpm por 15 segundos. Você irá ver as instruções na tela.



3. Pressione "ENTER" olhar a quantidade de ondulação pelo Sistema de carregamento da bateria. Um dos dois resultados do teste irá aparecer com o teste medido atual.

## ONDULAÇÃO DETECTADA NORMAL

Os diodos funcionam bem no alternador/estator.

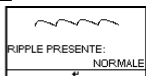

OU



## EXCESSO DE ONDULAÇÃO DETECTADO

Um ou mais diodes no alternador não estão funcionando ou tem um estator estragado. Cheque para ter certeza de que a montagem do alternador está fixionada seguramente e que os cintos estão em bom formato e funcionando apropriadamente. Se a montagem e os cintos estiverem em boas condições, substitua o alternador.



1. Pressione a chave "ENTER" para continuar o carregamento do Sistema com cargas. Um dos três resultados irá aparacer na tela com a medida do teste atual.

## CARREGAMENTO DO SISTEMA BAIXO QUANDO TEST COM CARGAS ACC.

O alternador está provendo corrente suficiente para a carga do sistema elétrico e o carregamento atual para a bateria. Checar os cintos para ter certeza de que o alternador está rodando com o motor em modo ligado. Se os cintos estiverem deslizando ou quebrados, troque-os e teste novamente. Checar as conexões do alternador com a bateria. Se as conexões estiverem frouxas ou muito corroídas, limpe-as ou troque o cabo e teste novamente. Se os cintos e as conexões estiverem em boas condições de funcionamento, troque o alternador.



## CARREGAMENTO DO SISTEMA NORMAL QUANDO TEST COM CARGAS ACC.

O Sistema está mostrando saída normal de um alternador, nenhum problema foi detectado.



## CARREGAMENTO DO SISTEMA ALTO QUANDO TEST COM CARGAS ACC.

A voltagem de saída do alternador para a bateria ultrapassa os limites normais de um regulador em funcionamento. Checar para ter certeza que não existem conexões frouxas e que a conexão no solo esta conectada apropriadamente. Se não tiver problemas com a conexão, substituir o regulador. Já que a maioria dos alternadores tem um regulador embutido, isto irá requerer a substituição do alternador.



1. Quando o teste estiver completo, a tela mostrará os resultados seguintes.

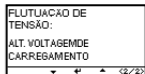

2. Pressione ENTRA para imprimir o teste.

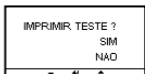
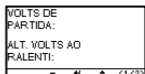

## TESTE IR

1. Pressione a chave ◀ ▶ para selecionar o teste IR.
2. Pressione a chave ◀ ▶ para confirmar a voltagem da bateria.
3. Pressione a chave ◀ ▶ SIM para confirmar se a bateria foi carregada recentemente.
4. Se a bateria não tiver sido carregada, por favor selecione "NÃO" para recarregar e retestar a bateria. Se a bateria tiver sido carregada, selecione "SIM" e proceda para o teste.
5. Aponte a "Temperatura de medida do sensor" 2.5cm (1 inch) do topo ou lados da capra da bateria e pressione "Enter". Medidas da temperatura vão variar de acordo com a distância da bateria, abaixo das condições do capu, e temperatura do gabinete.
6. Testando a bateria.
7. Quando o teste estiver completo, a tela mostrará os resultados seguintes.
8. Pressione ENTRA para imprimir o teste.

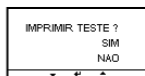
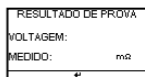
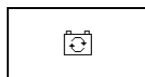
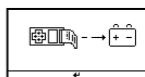
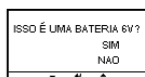
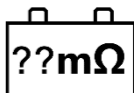



## VM/AM TESTE

### AM TESTE

1. Instale a bateria de 9V.
2. Conecte o medidor da braçadeira a tomada A no BT2100. Pressione LIGAR.
3. Pressione o botão zero. Tenha certeza de que a tela leia zero.
4. Pressione o gatilho para abrir as mandíbulas do transformador e prender um fio elétrico.
5. Tenha certeza de que as mandíbulas das braçadeiras estão perfeitamente fechadas.
6. Leia o valor na tela.

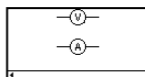

### VM TESTE

1. Ligue o Cabo de Teste Vermelho à tomada V no BT2100.
2. Use a ponta de prova para tocar o ponto entre a rede e a bateria.
3. Leia o valor na tela.

NOTA: Não teste o volt mais que 60v. Isso irá danificar o testador.

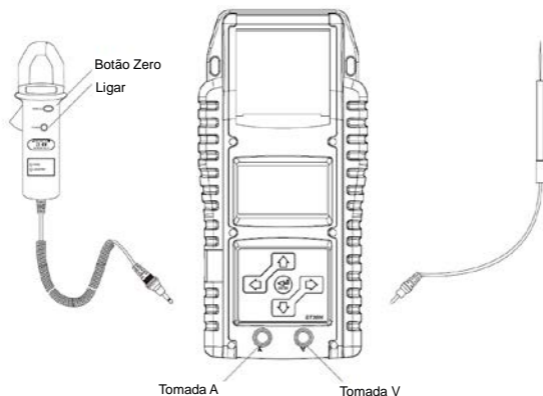

## CONFIGURAÇÃO E RECUPERAÇÃO DE INFORMAÇÃO

Pressione a chave ◀ ▶ para selecionar configuração.

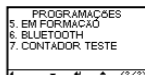
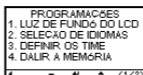

### LUZ TRASEIRA DO LCD

1. Pressione as chaves direcionais para ir a LUZ TRASEIRA DO LCD.
2. Pressione as chaves direcionais para ajustar o brilho da tela.
3. Pressione ENTER e a tela vai voltar para o menu.

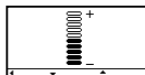

### SELECIONAR O IDIOMA

1. Pressione as chaves direcionais para ir a tela SELECIONAR O IDIOMA.
2. Pressione ENTER e a tela irá mostrar as opções de idiomas. Pressione as chaves direcionais para selecionar o idioma que você quer que seja mostrado na tela.
3. Pressione ENTER e a tela vai voltar para o menu.

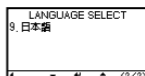
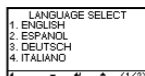

### CONFIGURAÇÃO DA TELA

1. Pressione as chaves direcionais para ir a tela DATE/TEMPO ATUAL.
2. Pressione ENTER e use o teclado virtual para ajustar o ANO/MES/DIA/HORAS/MINUTOS/SEGUNDOS e mude a configuração.
3. Pressione ENTER e a tela vai voltar para o menu.

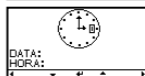

### LIMPAR MEMORIA

1. Pressione as chaves direcionais para ir para a tela APAGAR MEMORIA.
2. Selecione SIM para deletar a memória.
3. Pressione ENTER e retornará a tela do menu.

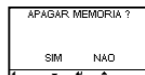

## INFORMAÇÃO

1. Pressione as chaves direcionais de INFORMAÇÃO.
2. Use as chaves direcionais para colocar dados customizados.
3. Pressione ENTER e retornará a tela do menu.

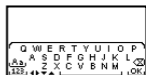

## BLUETOOTH

1. Pressione as chaves direcionais para entrar BLUETOOTH.
2. Pressione ENTRAR e a tela mostrará o estado da conexão.
3. Conect no APP e use isso para conectar o testador.

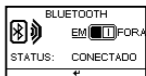
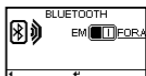

## CONTADOR TESTE

1. Pressione as chaves direcionais para entrar no CONTADOR TESTE.

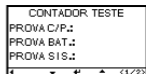

2. Pressione ↓ para imprimir e imprima o histórico do CONTADOR TESTE.

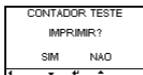
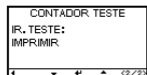

3. Pressione ENTRA para apagar específico histórico do Contador teste.

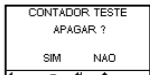

## GUIA DE NAVEGAÇÃO DO PC

Cada BT2100 vem com um CD, incluindo o arquivo para a instalação do programa DHC SYNC e o guia do usuário.

